



**PLANE
PRINT** *Seagull* EDF version



NOTE: Slicing only works with CURA!



You can find the STL data at www.planeprint.com

PRINTING THE PARTS – PRINTING PROFILES

You may wonder why this 3D model is exclusive to CURA?

The most important thing with small RC model airplanes is always the **size to weight ratio**. The lighter a model is, the better its flight characteristics and also the flight time is significantly increased.

With our **unique design process**, we manage to offer weight-relevant parts in a **true 1-wall printing** process for both the outer skin and the filling. This allows us to save weight while maintaining the necessary stability.

Here we show you how to make adjustments from a standard CURA profile.

For this model we need only 4, easy to create profiles.

It is important to follow the instructions from PLANEPRINT.com to slice the part correctly.

However, it can be useful to perfect your 3D printing by making some additional settings depending on the printer and filament used.

For slicing all Planeprint models, four profiles have to be created in Cura:

PROFILE P1_fullbody
PROFILE P2_hollowbody
PROFILE P3_surface
PROFILE P4_flex

You can find the description at www.planeprint.com/print

IMPORTANT FOR THE 1-WALL-PRINT!

In order to print airfoils of the lowest possible weight with high stability, it is necessary to print with only one wall line (Nozzle 0.4 mm). Decisive here is the adhesion between the layers! To achieve this, you must print at a much higher temperature than normal. As a **guideline**, 230 ° C is a good starting point. The parts-cooling fan should be set to 0% or a maximum of 20%. Since not every printer works the same, it may be necessary to make small adjustments to these settings.



The development of a complex, airworthy RC flight model to express on any standard 3D printer is a very complex and extensive process. Therefore, we appeal to your fairness not to forward the STL data you have acquired to third parties. Our STL files are provided with indelible copyright watermarks that can be verified at any time.

Thank you for your understanding and have fun with your PLANEPRINT MODEL!

PROFILE P1_FULLBODY

The following parts must be sliced with the PROFILE P1_FULLBODY.
Please note the additional settings for the individual parts!

Central piece EDF_profile1_sg.stl

MATERIAL PLA, Weight: ~ 16 g

ADDITIONAL SETTINGS

None required

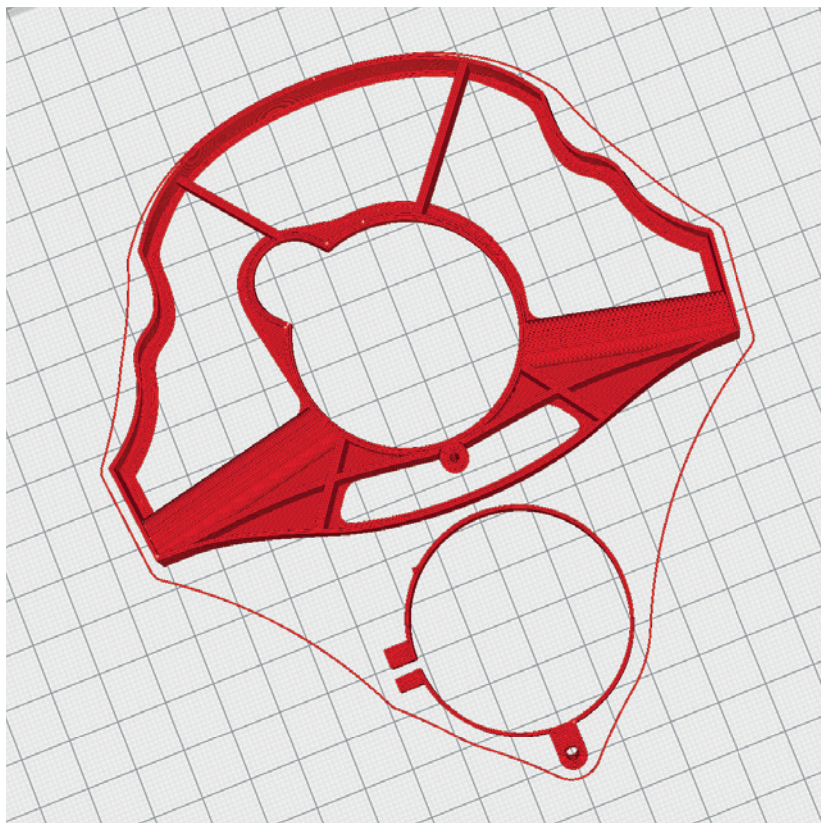

Servo mount_profile1_sg.stl

MATERIAL PLA, ~ 7 g

ADDITIONAL SETTINGS

None required

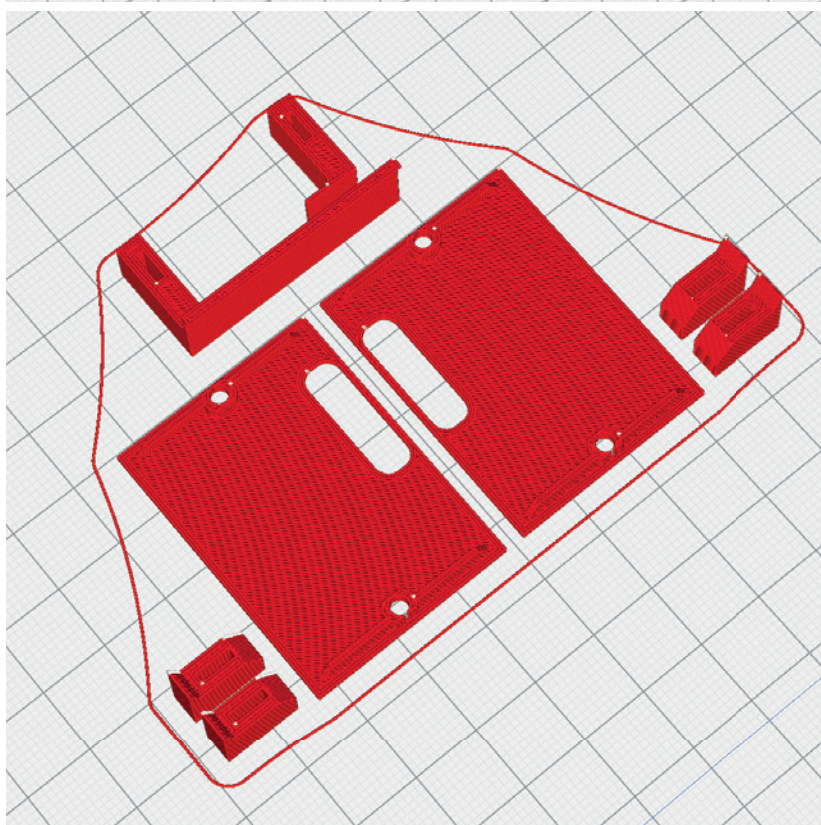

PROFILE P1_FULLBODY

The following parts must be sliced with the PROFILE P1_FULLBODY.
Please note the additional settings for the individual parts!

Small parts_profile1_sg.stl

MATERIAL PLA, ~ 4 g

ADDITIONAL SETTINGS

None required

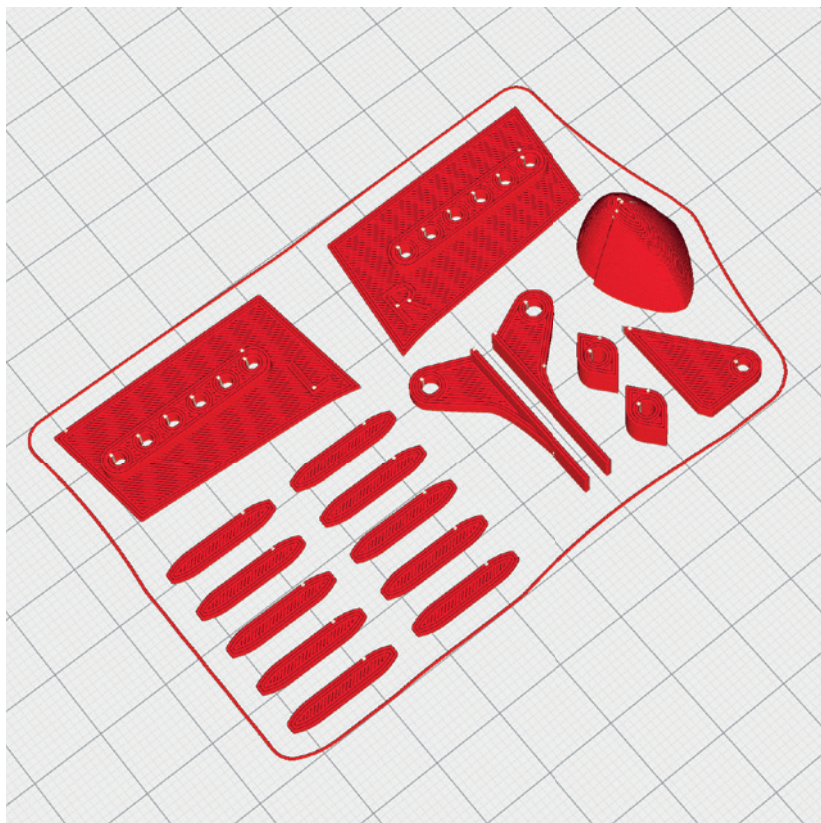

PROFILE P3_SURFACE PLA or Tough PLA

The following parts must be sliced with the PROFILE P3_SURFACE (1-wall-print).

Please note the additional settings for the individual parts!

PLEASE NOTE In profile P3_SURFACE, there should not be more than one STL on the buildplate at the same time, otherwise slicing errors can occur! Depending on your printer, a brim may not be required.

Fuselage 2-EDF_profile3_sg.stl

MATERIAL PLA, ~ 50 g

ADDITIONAL SETTINGS

None required

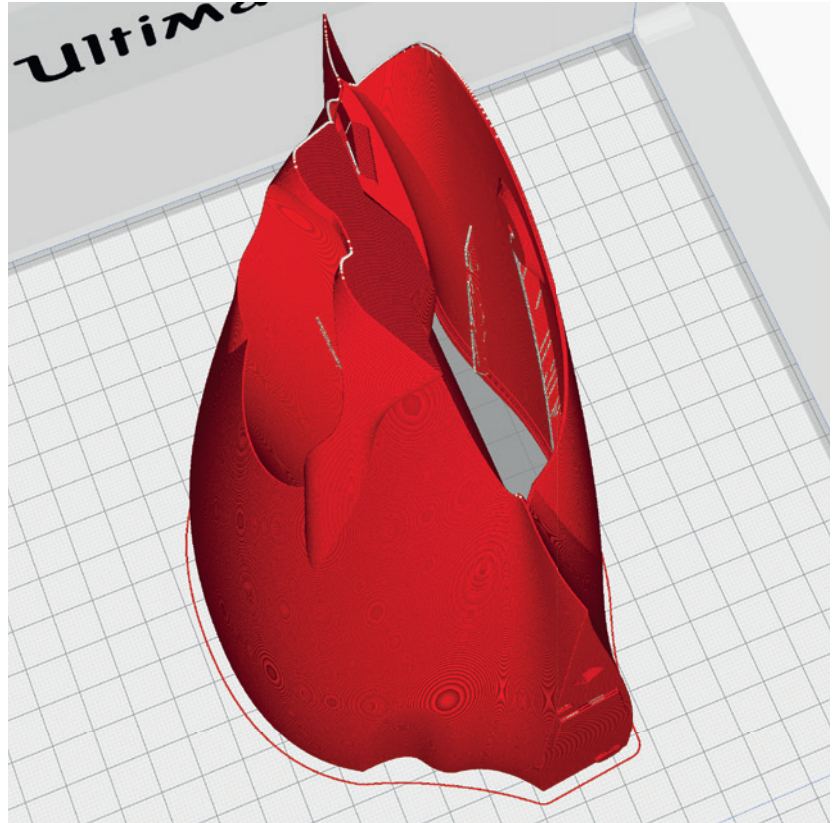

Fuselage 1-EDF_profile3.stl

MATERIAL PLA, ~ 44 g

ADDITIONAL SETTINGS

None required

Info: This area is support that will be removed later:

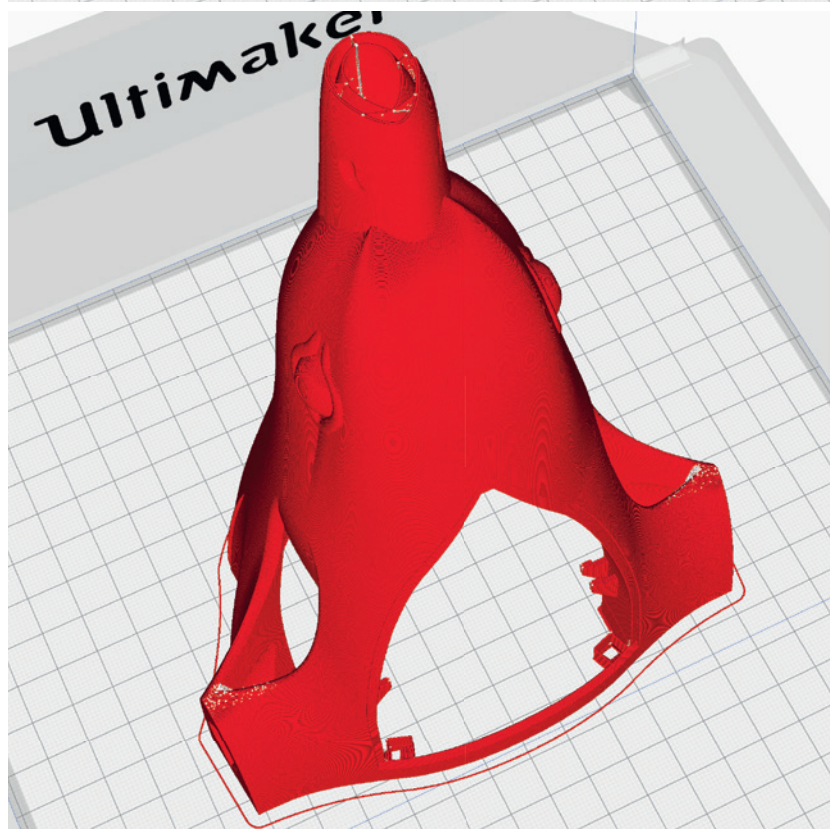
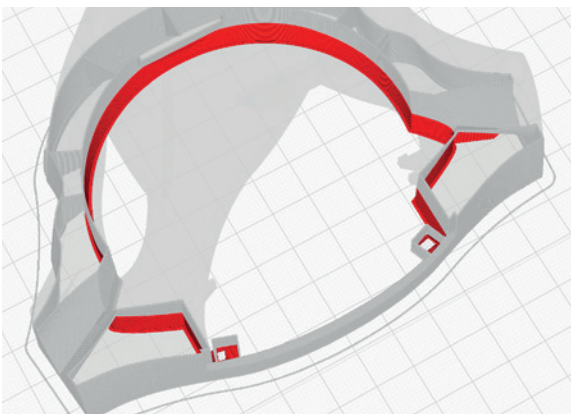

PROFILE P3_SURFACE PLA or Tough PLA

The following parts must be sliced with the PROFILE P3_SURFACE (1-wall-print).

Please note the additional settings for the individual parts!

PLEASE NOTE In profile P3_SURFACE, there should not be more than one STL on the buildplate at the same time, otherwise slicing errors can occur! Depending on your printer, a brim may not be required.

Cover-EDF_profile3.stl

MATERIAL PLA, ~ 6 g

ADDITIONAL SETTINGS

None required

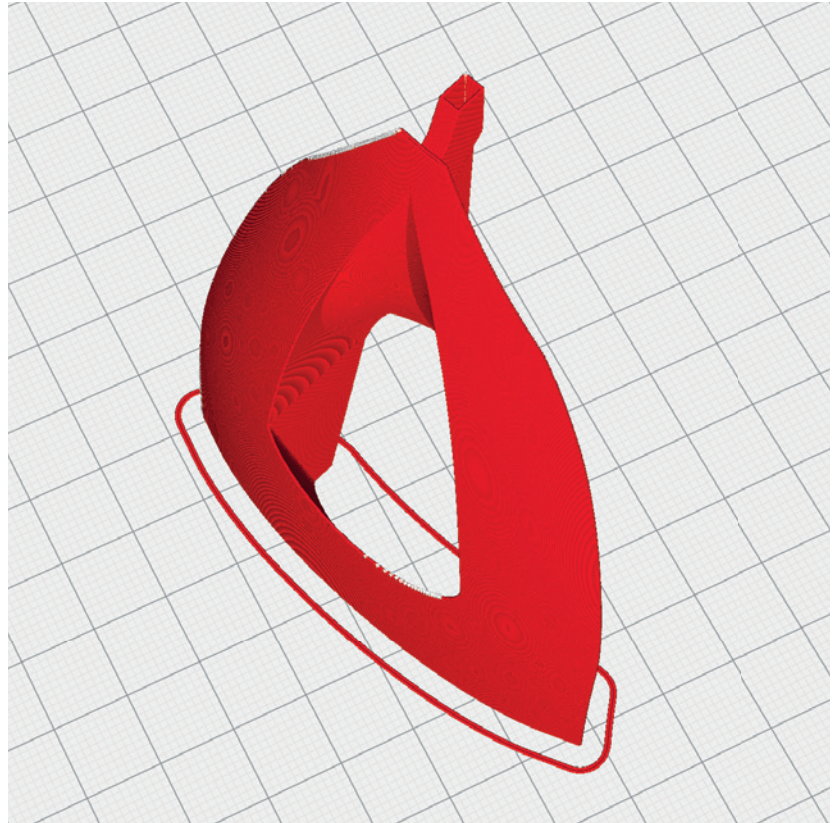

PROFILE P3_SURFACE Light-Weight LW-PLA

The following parts must be sliced with the PROFILE P3_SURFACE (1-wall-print).

Please note the additional settings for the individual parts!

PLEASE NOTE In profile P3_SURFACE, there should not be more than one STL on the buildplate at the same time, otherwise slicing errors can occur! Depending on your printer, a brim may not be required.

Aileron1-LW-left_profile3_sg.stl
Aileron1-LW-right_profile3_sg.stl

MATERIAL LW-PLA, ~ 10 g*

*Display in Cura. The actual weight is 6 grams

ADDITIONAL SETTINGS

- Setting Profile3_Surface
- Flow 60 % or less
- Higher nozzle temperature

The optimal weight and sufficient strength is achieved with 60 % flow. Increase the temperature until the wall thickness is 0.4 to 0.5 mm. (We print at 250° and 60% flow).

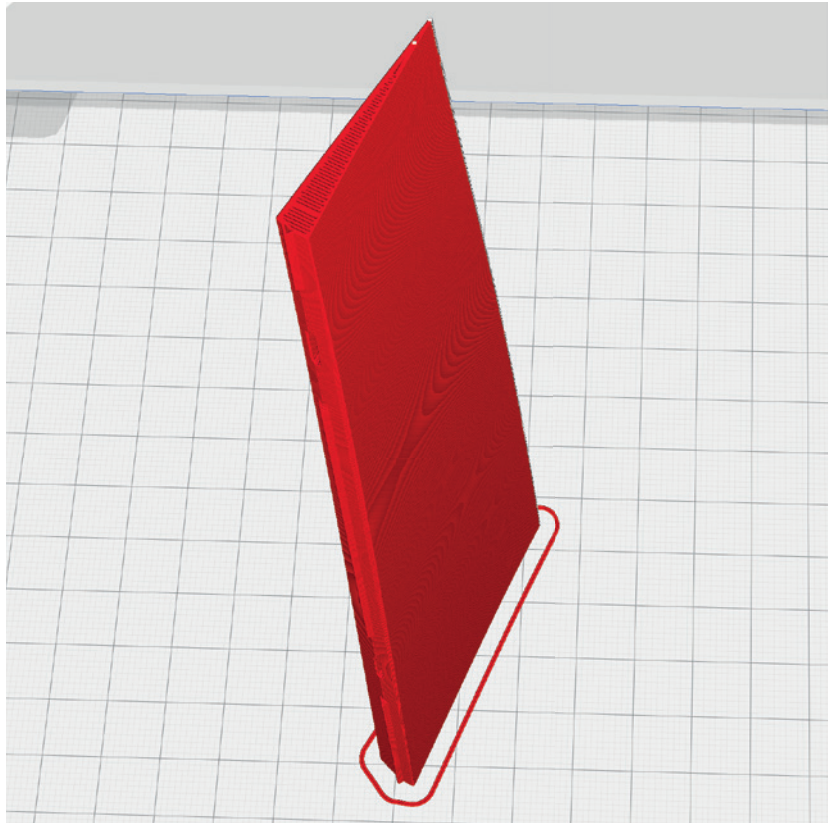

Aileron2-LW-left_profile3_sg.stl
Aileron2-LW-right_profile3_sg.stl

MATERIAL LW-PLA, ~ 12 g*

*Display in Cura. The actual weight is 8 grams

ADDITIONAL SETTINGS

- Setting Profile3_Surface
- Flow 60 % or less
- Higher nozzle temperature

The optimal weight and sufficient strength is achieved with 60 % flow. Increase the temperature until the wall thickness is 0.4 to 0.5 mm. (We print at 250° and 60% flow).

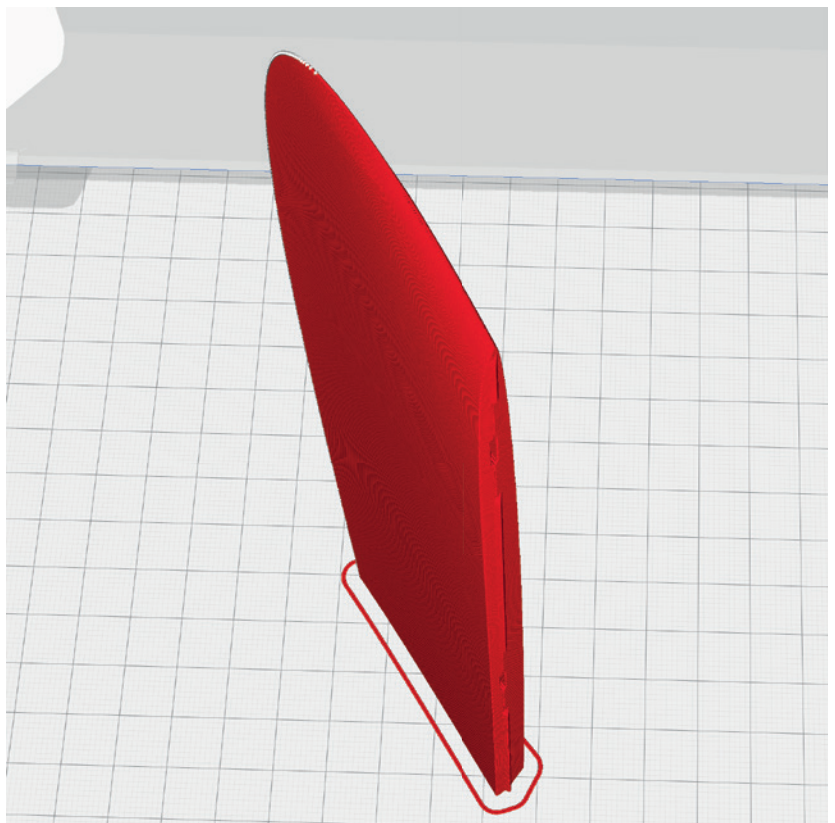

PROFILE P3_SURFACE Light-Weight LW-PLA

The following parts must be sliced with the PROFILE P3_SURFACE (1-wall-print).

Please note the additional settings for the individual parts!

PLEASE NOTE In profile P3_SURFACE, there should not be more than one STL on the buildplate at the same time, otherwise slicing errors can occur! Depending on your printer, a brim may not be required.

Tail-LW_profile3_sg.stl

MATERIAL LW-PLA, ~ 35 g*

*Display in Cura. The actual weight is 19 grams

ADDITIONAL SETTINGS

- Setting Profile3_Surface
- Flow 60 % or less
- Higher nozzle temperature

The optimal weight and sufficient strength is achieved with 60 % flow. Increase the temperature until the wall thickness is 0.4 to 0.5 mm. (We print at 250° and 60% flow).

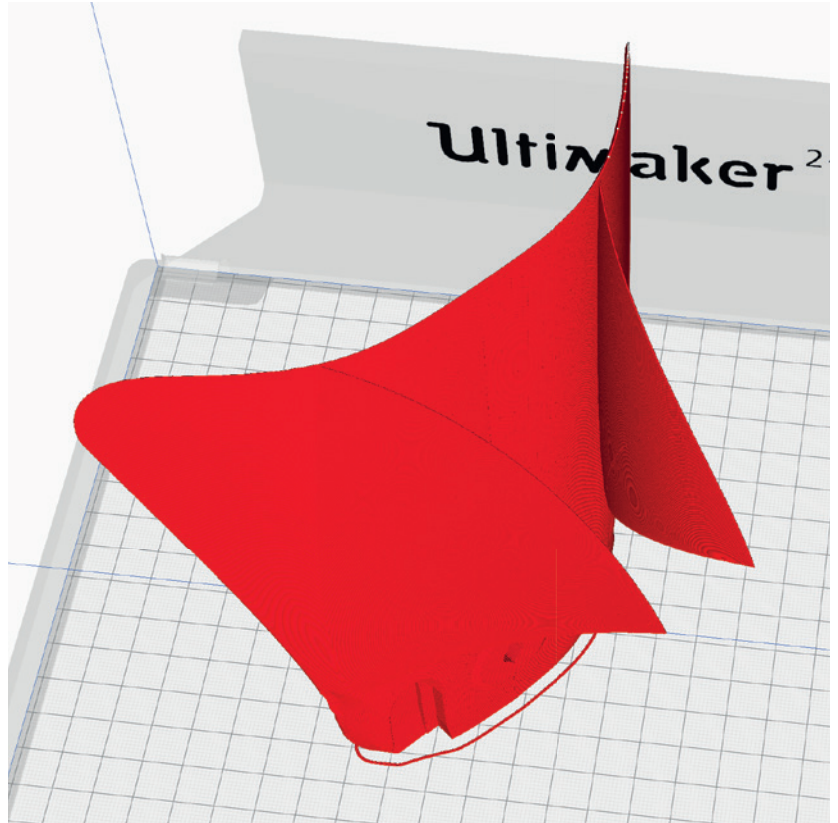

Wing 1-LW-left_profile3_sg.stl Wing 1-LW-right_profile3_sg.stl

MATERIAL LW-PLA, ~ 56 g*

*Display in Cura. The actual weight is 29 grams

ADDITIONAL SETTINGS

- Setting Profile3_Surface
- Flow 60 % or less
- Higher nozzle temperature

The optimal weight and sufficient strength is achieved with 60 % flow. Increase the temperature until the wall thickness is 0.4 to 0.5 mm. (We print at 250° and 60% flow).

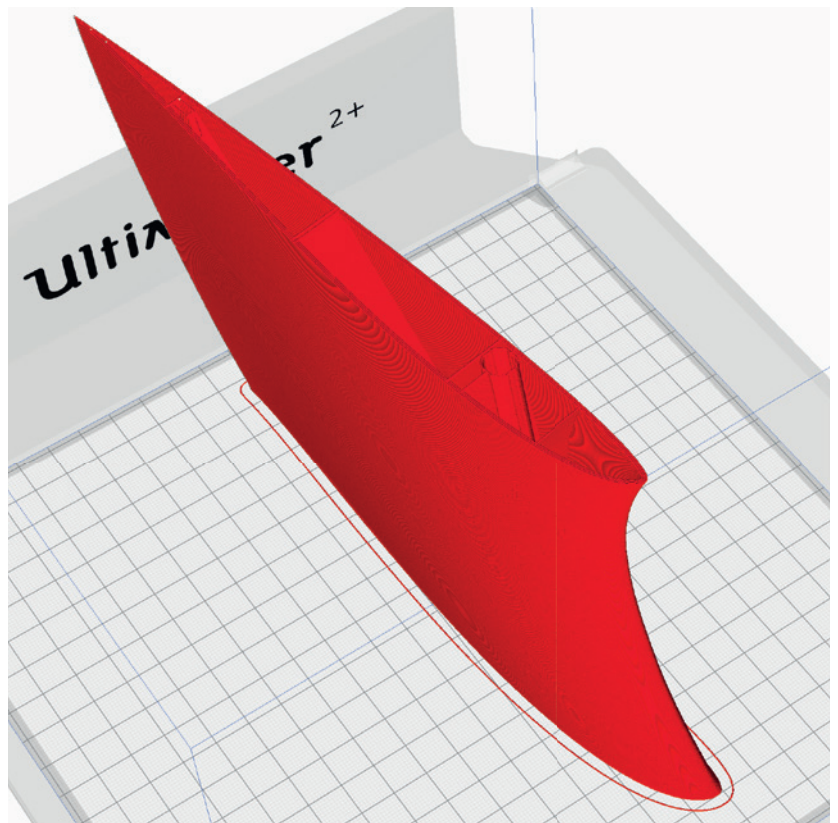

PROFILE P3_SURFACE Light-Weight LW-PLA

The following parts must be sliced with the PROFILE P3_SURFACE (1-wall-print).

Please note the additional settings for the individual parts!

PLEASE NOTE In profile P3_SURFACE, there should not be more than one STL on the buildplate at the same time, otherwise slicing errors can occur! Depending on your printer, a brim may not be required.

Wing 2-LW-left_profile3_sg.stl Wing 2-LW-right_profile3_sg.stl

MATERIAL LW-PLA, ~ 55 g*

*Display in Cura. The actual weight is 28 grams

ADDITIONAL SETTINGS

- Z Seam Position: Wing left: **Back Left**
Wing right: **Back Right**
- Setting Profile3_Surface
- Flow 60 % or less
- Higher nozzle temperature

The optimal weight and sufficient strength is achieved with 60 % flow. Increase the temperature until the wall thickness is 0.4 to 0.5 mm. (We print at 250° and 60% flow).

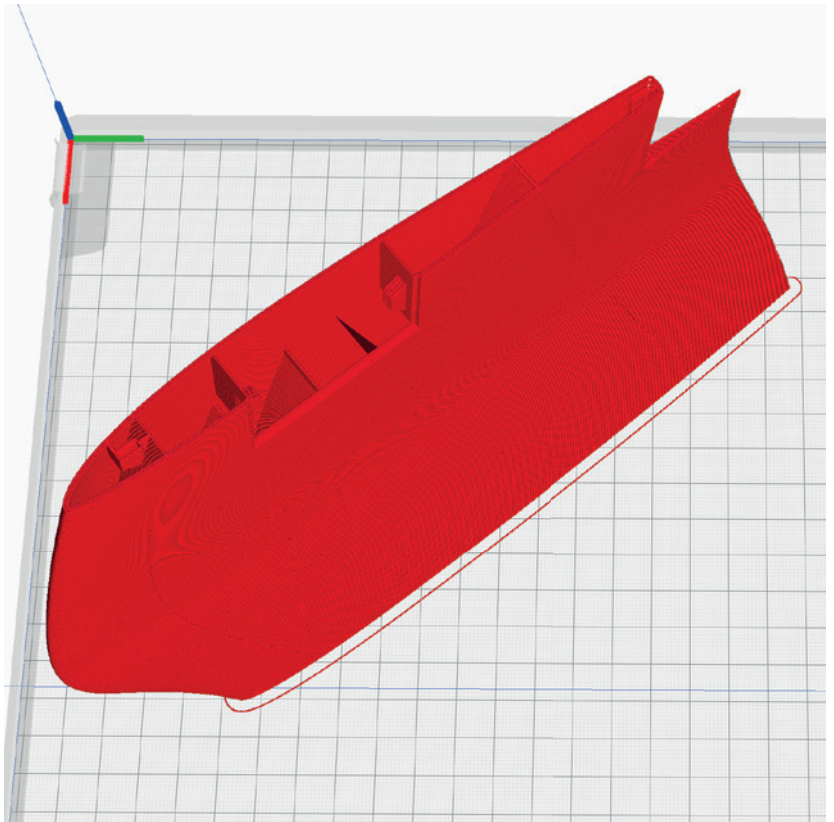

Wing 3-LW-left_profile3_sg.stl Wing 3-LW-right_profile3_sg.stl

MATERIAL LW-PLA, ~ 36 g*

*Display in Cura. The actual weight is 19 grams

ADDITIONAL SETTINGS

- Setting Profile3_Surface
- Flow 60 % or less
- Higher nozzle temperature

The optimal weight and sufficient strength is achieved with 60 % flow. Increase the temperature until the wall thickness is 0.4 to 0.5 mm. (We print at 250° and 60% flow).

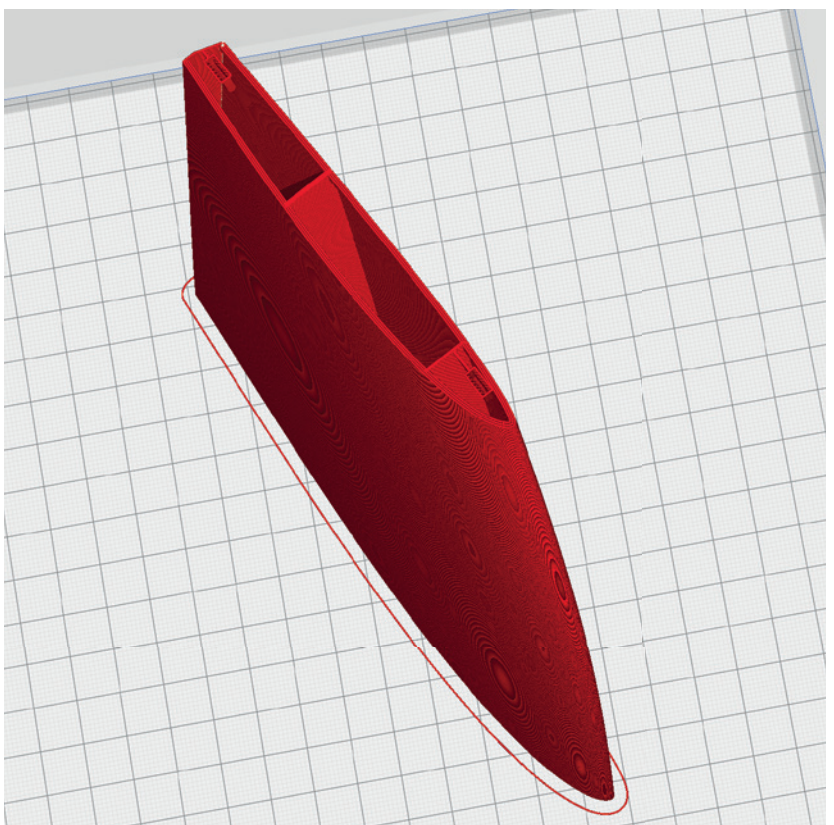

PROFILE P3_SURFACE Light-Weight LW-PLA

The following parts must be sliced with the PROFILE P3_SURFACE (1-wall-print).

Please note the additional settings for the individual parts!

PLEASE NOTE In profile P3_SURFACE, there should not be more than one STL on the buildplate at the same time, otherwise slicing errors can occur! Depending on your printer, a brim may not be required.

Wing 4-LW-left_profile3_sg.stl
Wing 4-LW-right_profile3_sg.stl

MATERIAL LW-PLA, ~ 12 g*

*Display in Cura. The actual weight is 8 grams

ADDITIONAL SETTINGS

- Setting Profile3_Surface
- Flow 60 % or less
- Higher nozzle temperature

The optimal weight and sufficient strength is achieved with 60 % flow. Increase the temperature until the wall thickness is 0.4 to 0.5 mm. (We print at 250° and 60% flow).

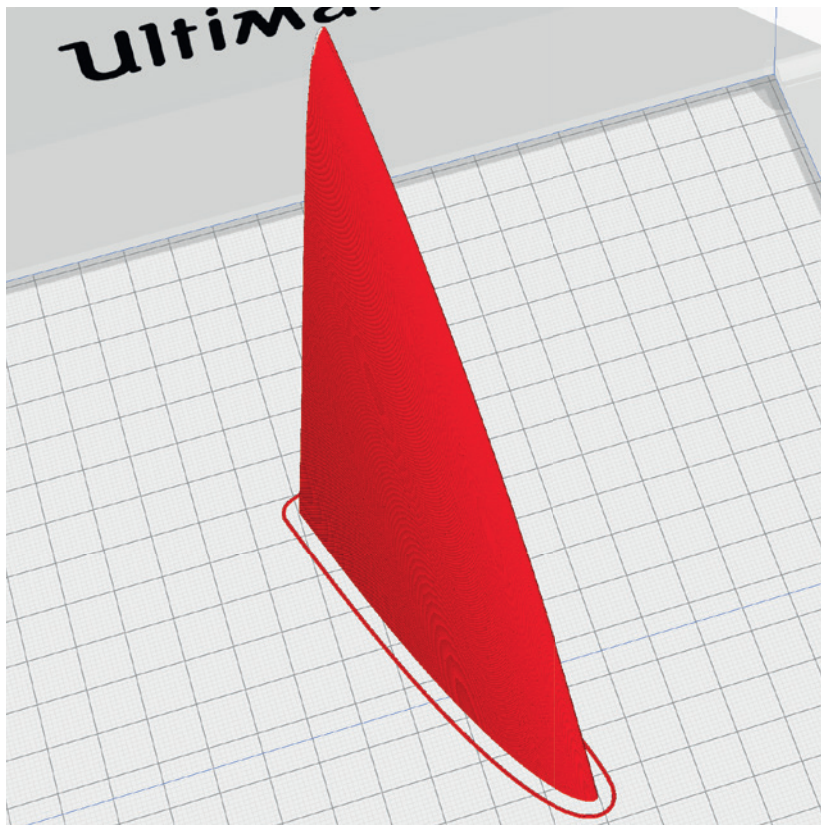

PROFILE P4_FLEX TPU A95

The following parts must be sliced with the PROFILE P4_FLEX.
Please note the additional settings for the individual parts!

Hinges_profile4_sg.stl

MATERIAL TPU ~ A95, Weight: ~ 1 g

ADDITIONAL SETTINGS

None required

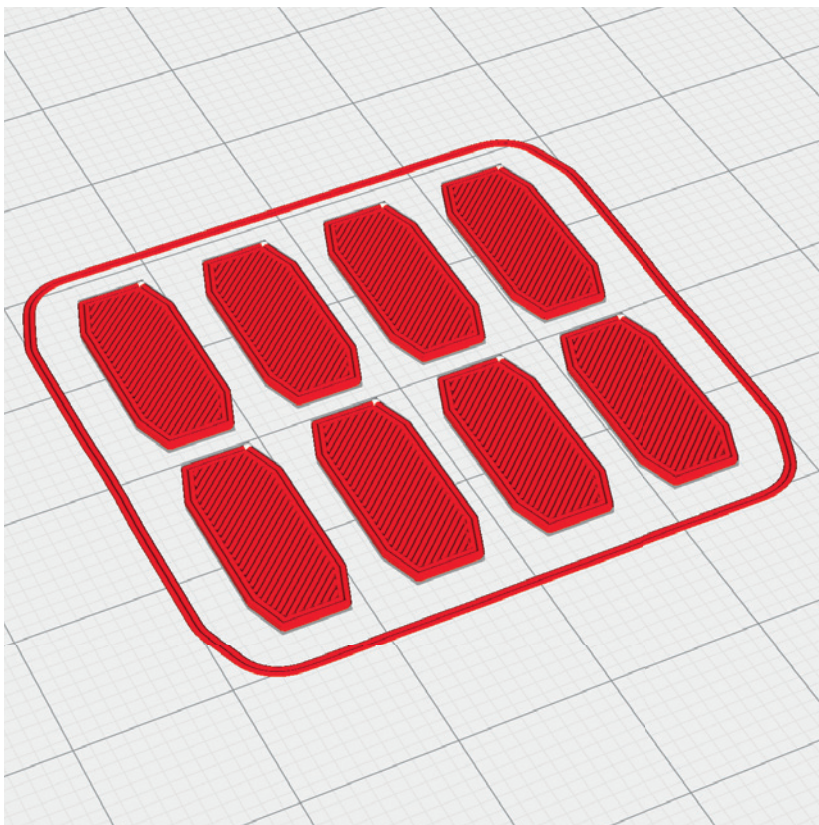

Tension belts_profile4_sg.stl

MATERIAL TPU ~ A95, Weight: ~ 2 g

ADDITIONAL SETTINGS

- Infill Density: 100 %

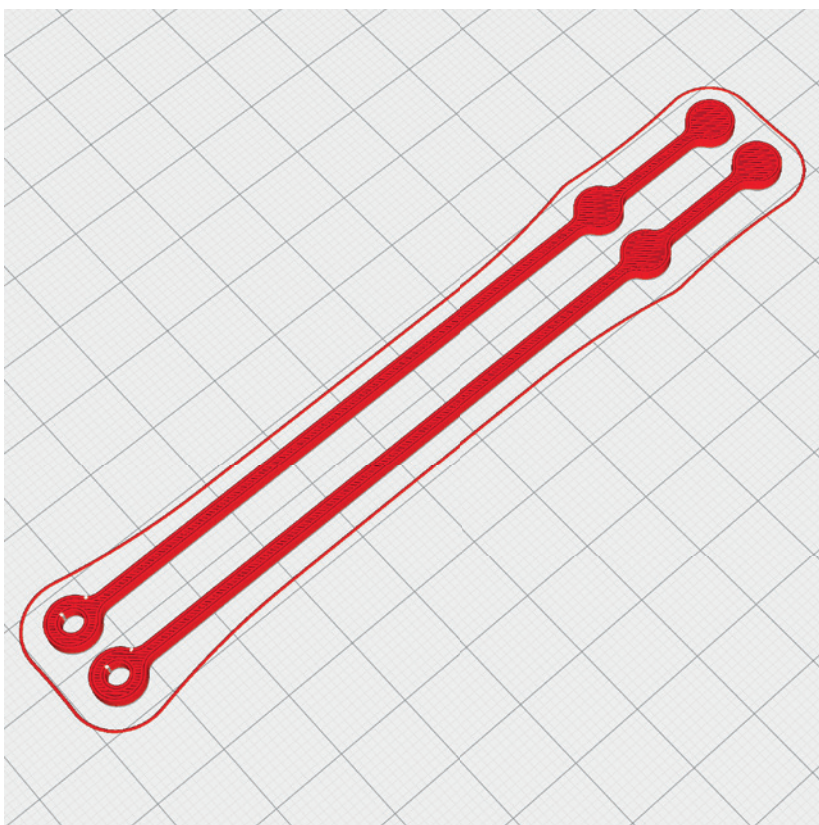

REQUIRED ACCESSOIRES

Filament

- normal PLA about 130 grams
- LW-PLA about 120 grams (**ABSOLUTELY NECESSARY**)
We recommend using white (natural) LW-PLA, which heats up much less in direct sunlight.
- TPU (A95) about 5 grams

Materials

- some tapping screws $\text{Ø}2 \times 8$ mm
(**simply search for: M2 flat head tapping screw assortment**) →
- CA super glue (liquid and liquid medium)
- CA activator
- Carbon tube $\text{Ø}6\text{mm} \times 305\text{mm}$ (inside 4mm), 2 pieces
- Steel wire $\text{Ø}0.8\text{mm} \times 400\text{mm}$ (or $\text{Ø}1\text{mm}$ for the servo linkages)
- small Rod connection, 3 pieces



Tools

- Cutter knife
- small Philips screwdriver
- Drill $\text{Ø}1.5\text{mm}$
- needle-nose pliers

RC COMPONENTS

2S-Setting (Like our Seagull from the official Planeprint video)

EDF Pichler THRUST EDF Ø 40mm

BEC-CONTROLLER 30A (one matching the motor)

RECEIVER 4 Channel

BATTERY 2S Lipo, 1500 MaH

SERVOS 3 pieces

- PLANET-HOBBY ECO PLUS
- PICCO 8 DIGITAL SERVO
- Diamond D47
- Hitec HS 40 Eco Servo 4,8g
- Hitec HS-5055MG

Maximum dimensions:

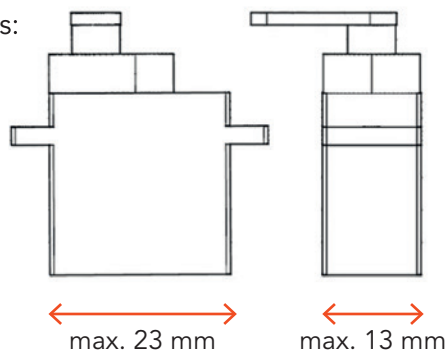

THRUST



+



PLANE PRINT *Seagull* EDF version

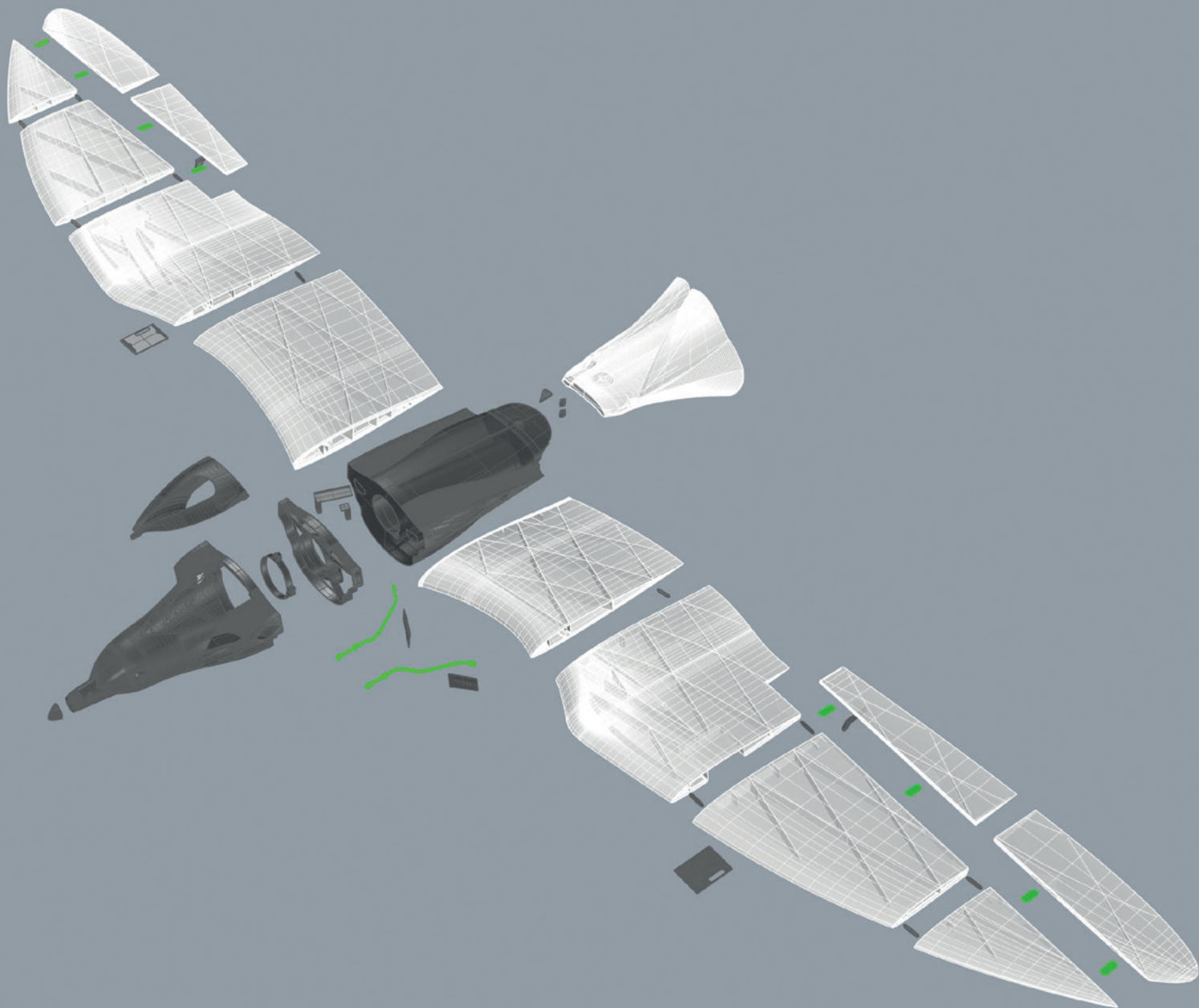

LW-PLA



PLA



TPU

ASSEMBLING MANUAL – Basic information

Gluing the parts

To glue the fuselage and wing parts well, use **medium-liquid CA** adhesive.

First check whether the parts go well together. Then apply a lot of CA glue to the part with the connections and all surfaces that will touch later (except the bowden tubes!). Put the parts together and align the parts perfectly. If glue comes out, wipe with a cloth. Then spray activator spray on the glue points.

IMPORTANT For a strong connection, the adhesive surfaces should be sanded. Please only use fresh CA glue and activator spray for curing! The adhesive connections must hold perfectly!

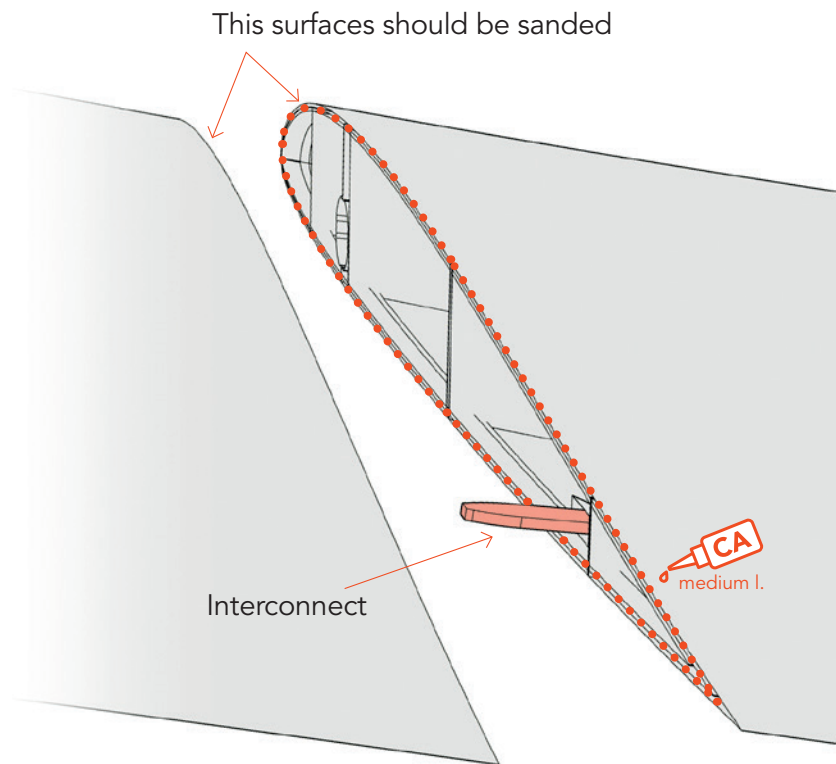

Installation of the TPU hinges

First insert the hinge into the wing and add a drop of liquid CA adhesive into the gap. Wait for the glue to drain completely, then spray the activator on it.

Then put the flap in the wing and put a drop of CA glue on the hinge. Wait again for the glue to run in, and then spray the activator on it.

Do not use too much glue, the flap must move easily!

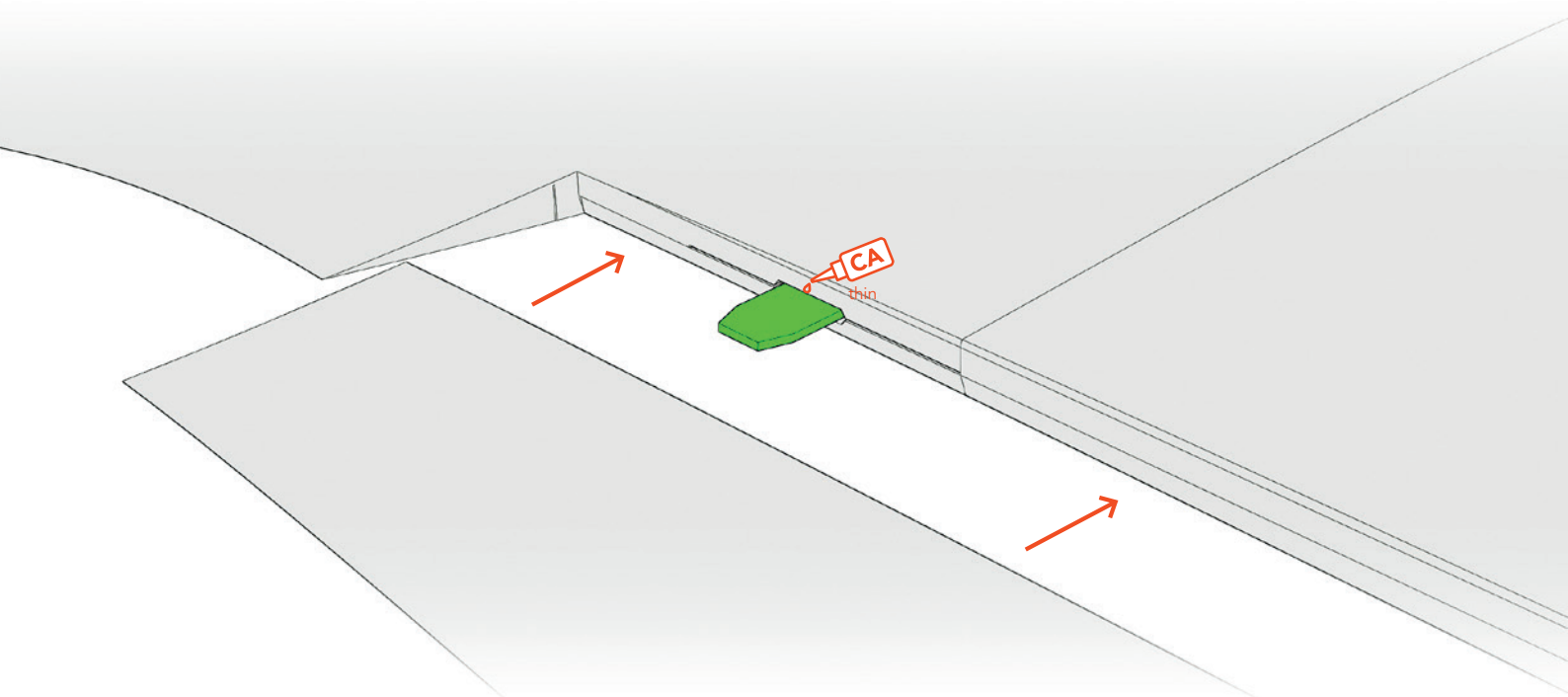

Wings assembly



Use the carbon tube for exact positioning of the wing parts.

The tube should not be glued!

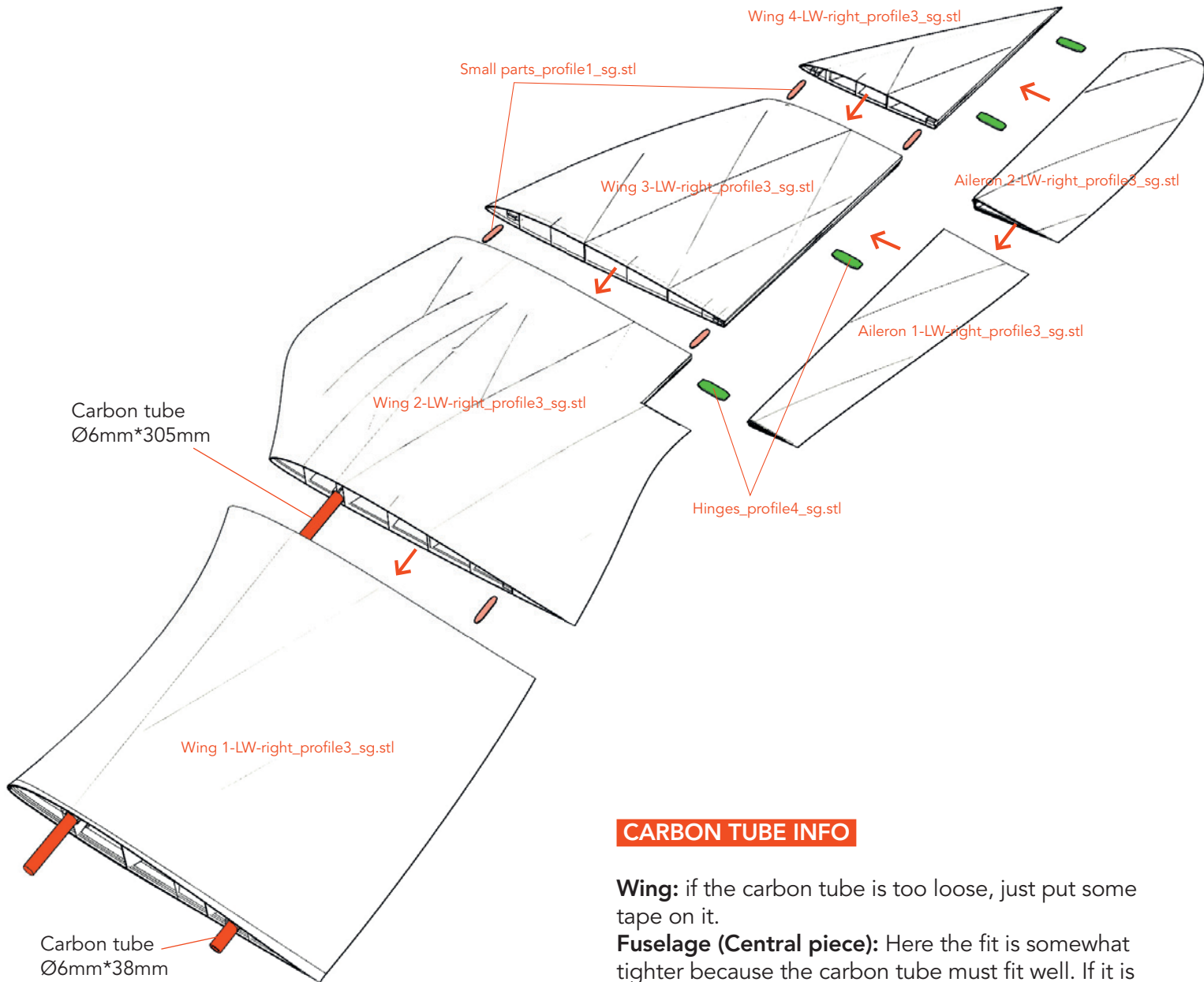

CARBON TUBE INFO

Wing: if the carbon tube is too loose, just put some tape on it.
Fuselage (Central piece): Here the fit is somewhat tighter because the carbon tube must fit well. If it is too stiff, you can open it up a bit with a 6mm drill bit. You can also use a piece of carbon tube as a drill. Due to the frictional heat, the PLA adapts.

Fuselage assembly – rudder servo

It is easier to mount the servo for the rudder before mounting the fuselage.

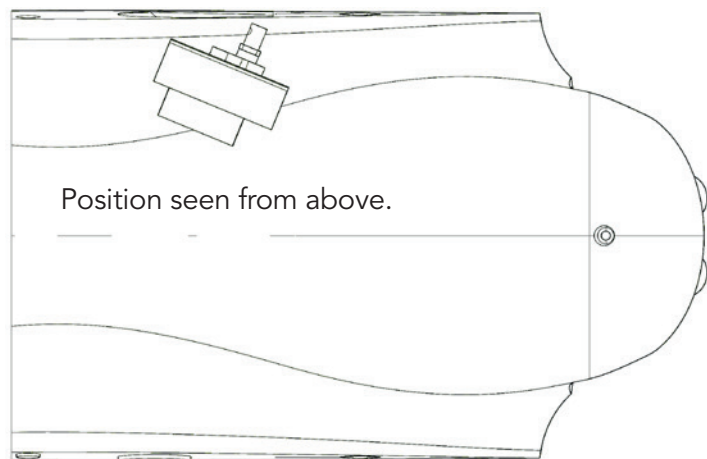
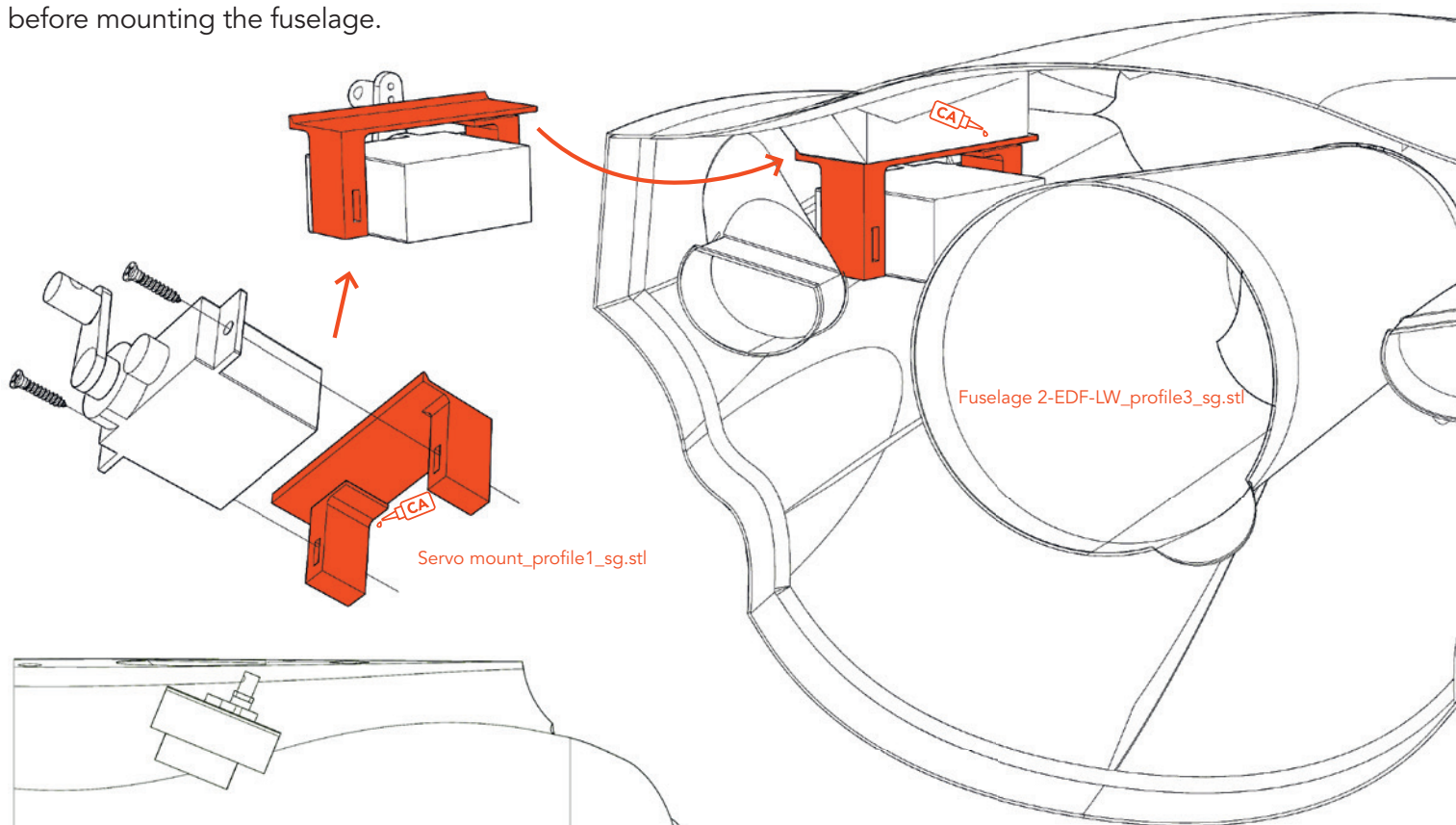

Pin the parts together and then let thin CA glue run into the gap.

Seen from the side:

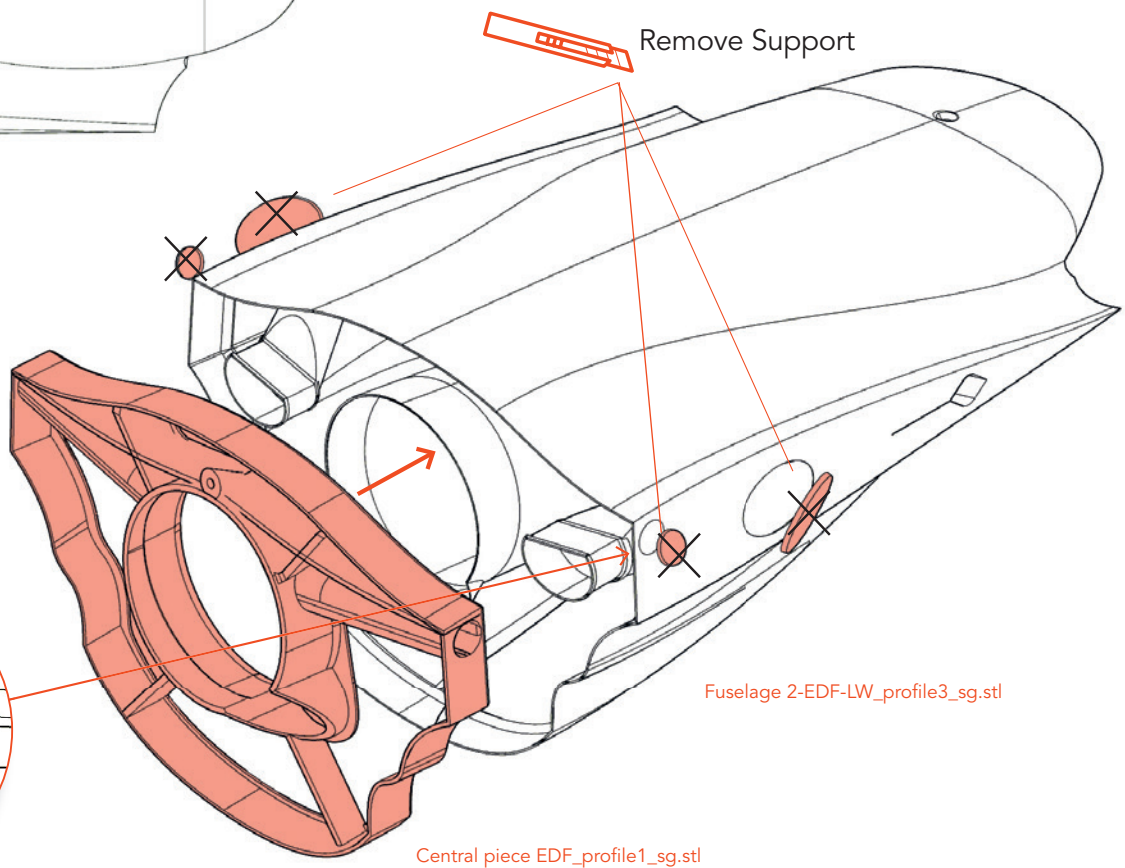
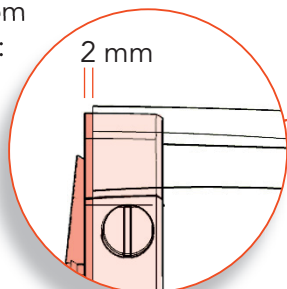

Fuselage assembly



First remove support:

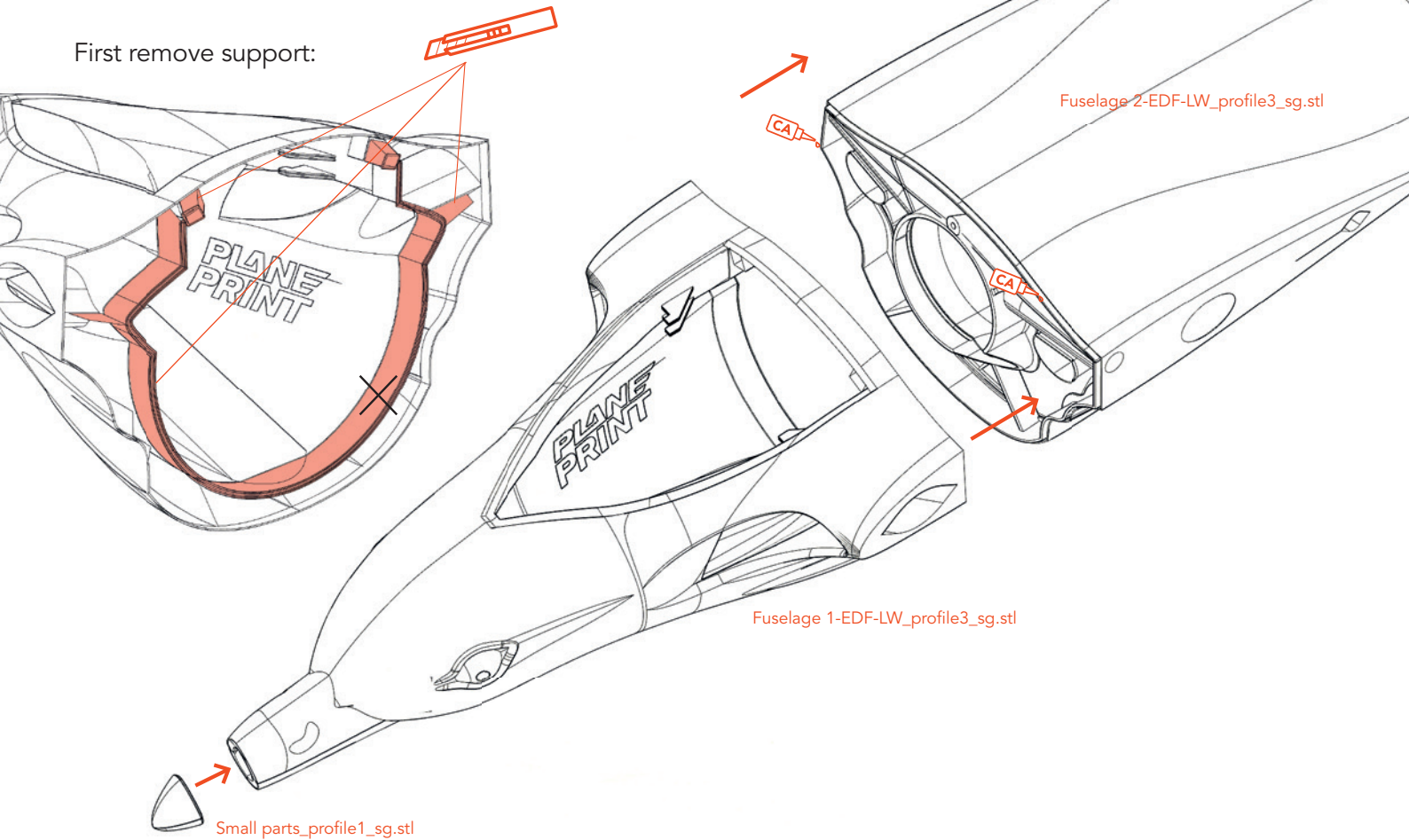

Cover mount

Put the four magnets into the gaps, usually no glue is needed.

Pay attention to the alignment of the magnets to each other!

Neodym Super Magnets 5x5x5 mm

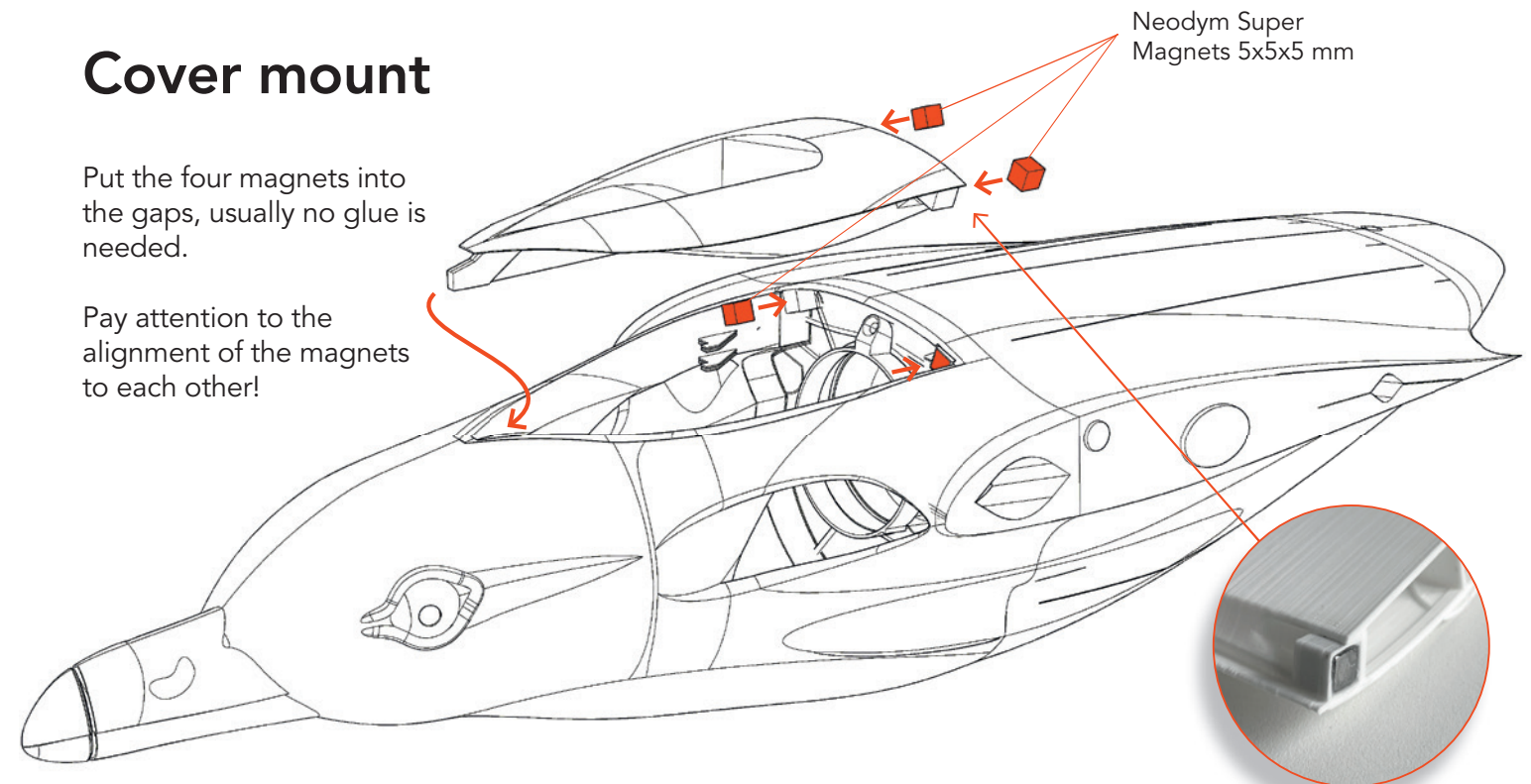

Tailplane assembly

Glue the three parts ([Small parts_profile1.stl](#)) as shown in the picture and insert the steel wire into the rudder horn. Then insert the tail into the fuselage and screw it into the joint from above and below.

Make sure that the tail moves easily!

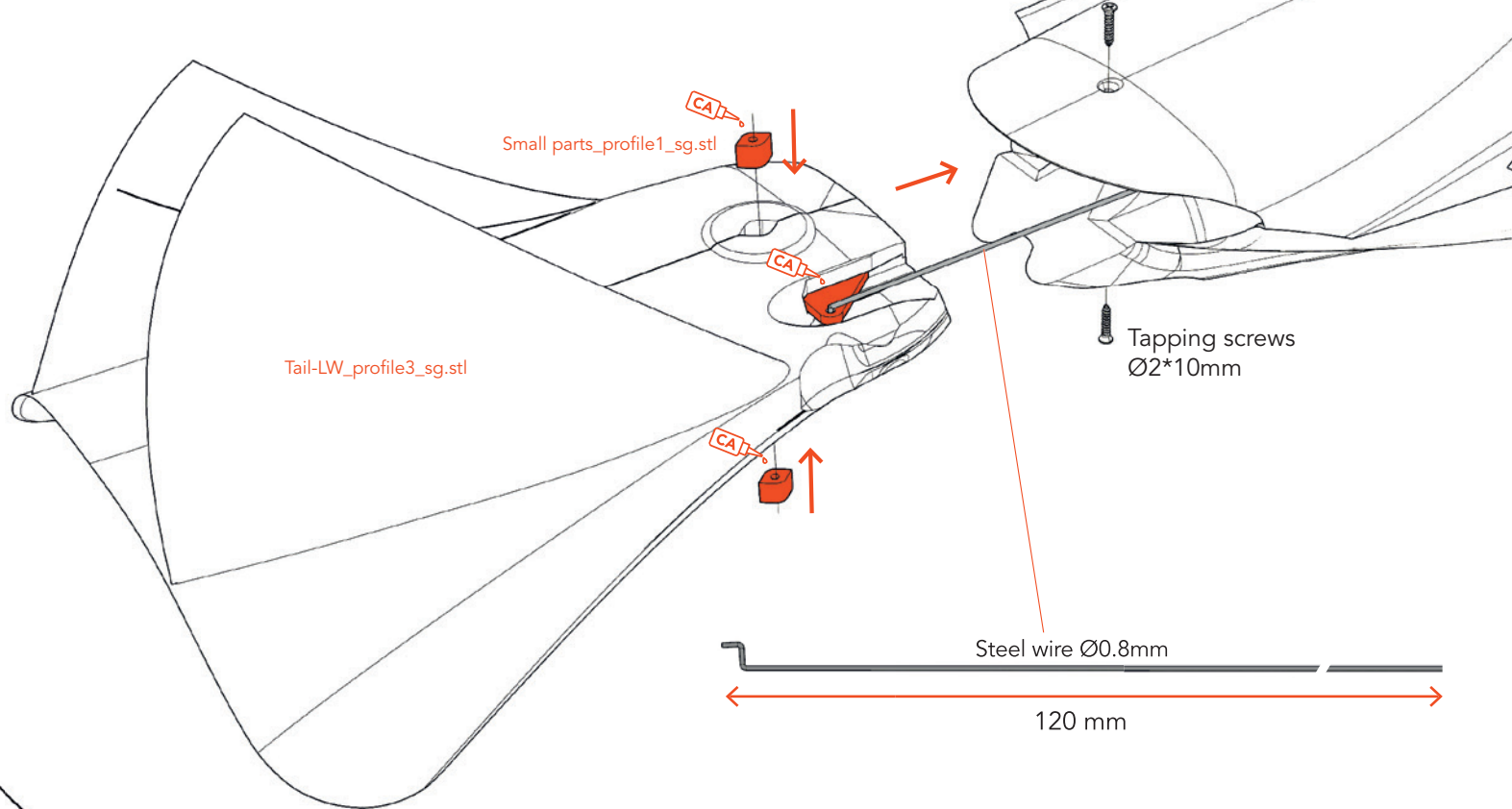

Connect the steel wire to the servo.

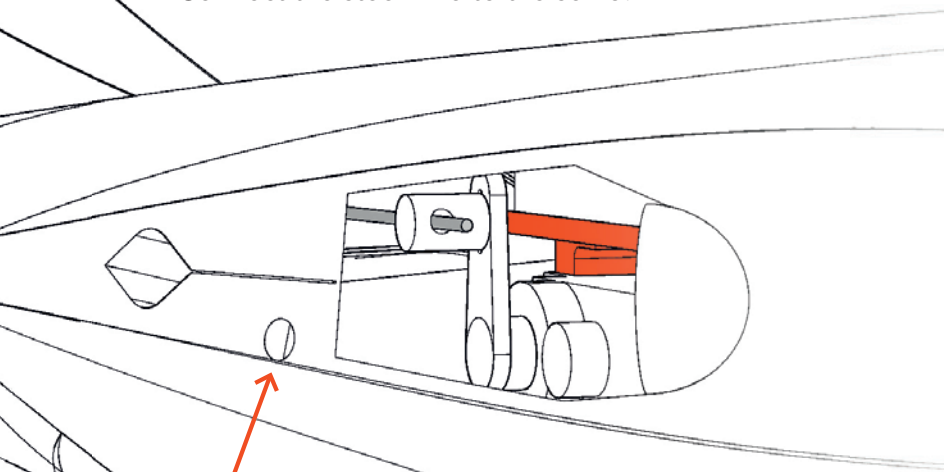

This hole can be opened to remove the servo later.

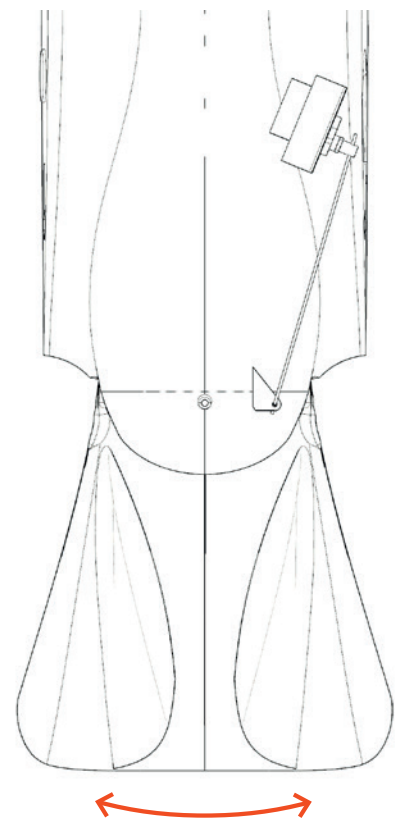

Aileron Servo

Assemble the parts as shown here. Tighten the servo cover with tapping screws. The holes in the wing must be drilled beforehand. The easiest way to do this is to heat a piece of steel wire with a flame to melt the hole for the screw.

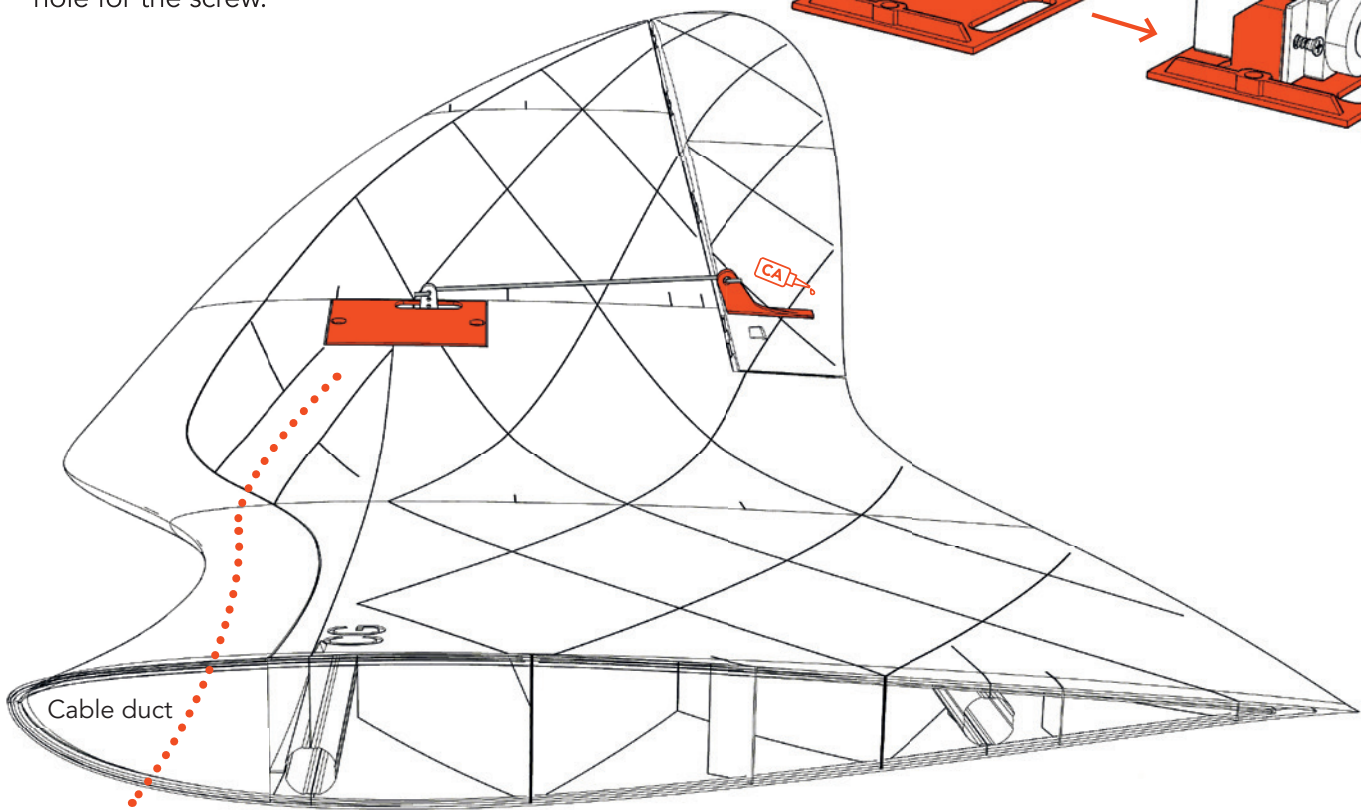
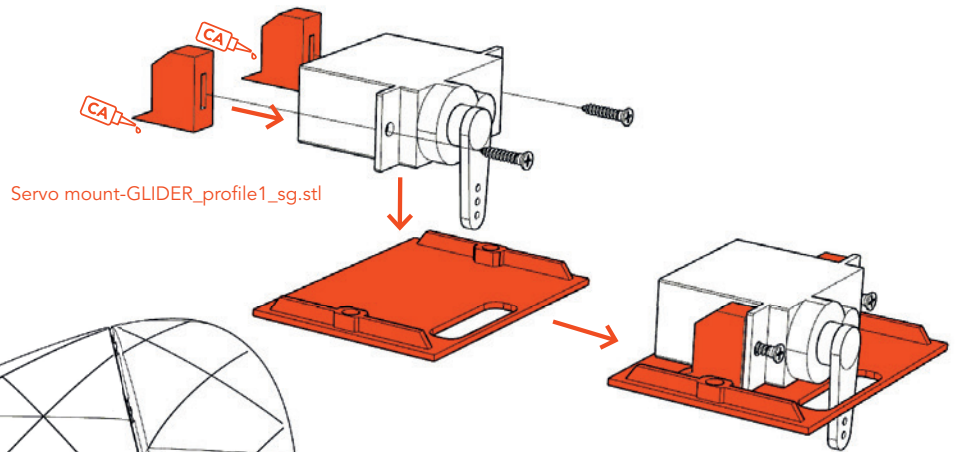

Wing mounting system

Glue the retaining plate to this rib of the wing and then tighten the tension belt to the outermost screw.

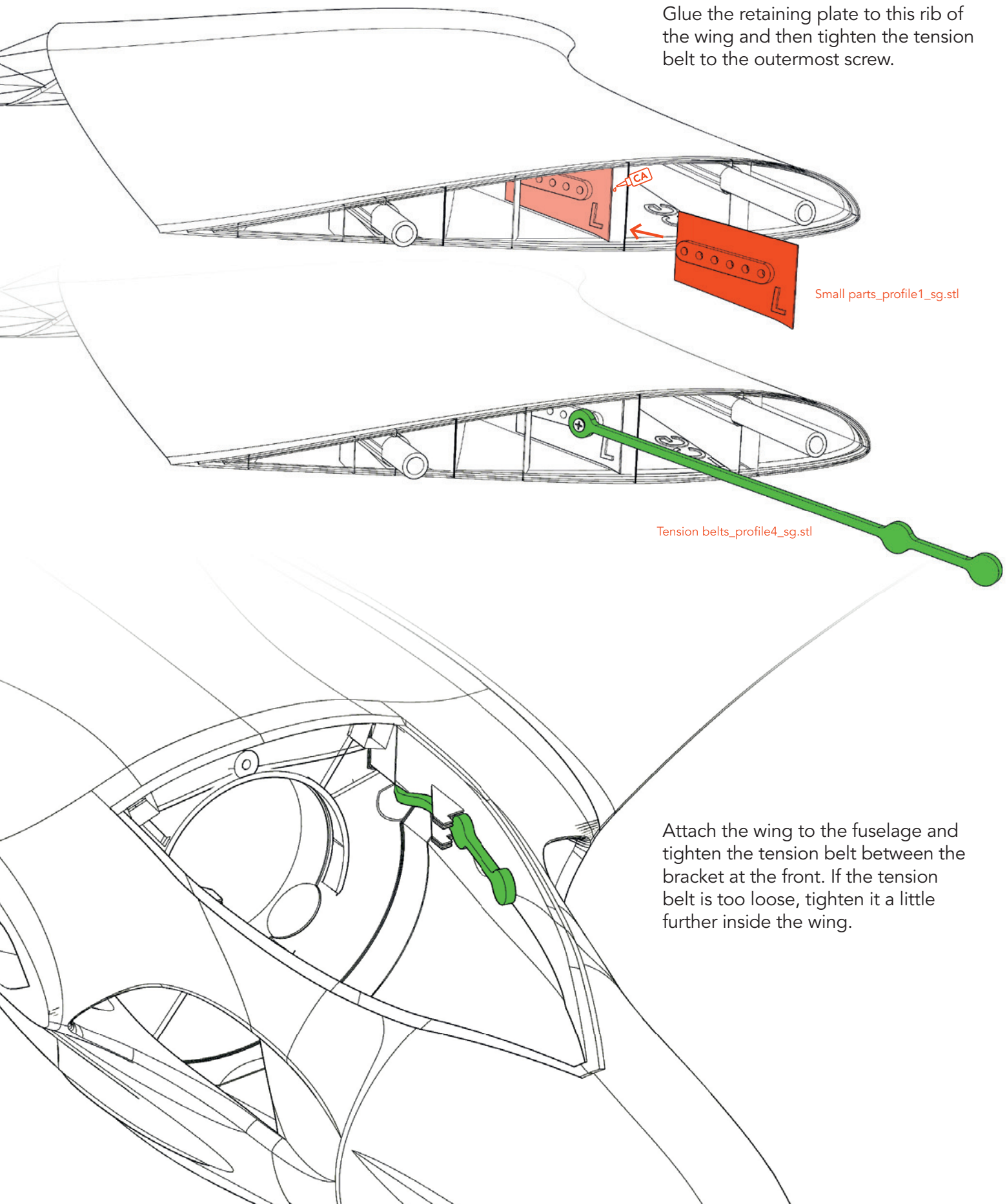

Small parts_profile1_sg.stl

Tension belts_profile4_sg.stl

Attach the wing to the fuselage and tighten the tension belt between the bracket at the front. If the tension belt is too loose, tighten it a little further inside the wing.

EDF mounting

Tighten the clamping ring at the very front of the EDF. **Turn the EDF so that the cables point in the direction of the marking.**

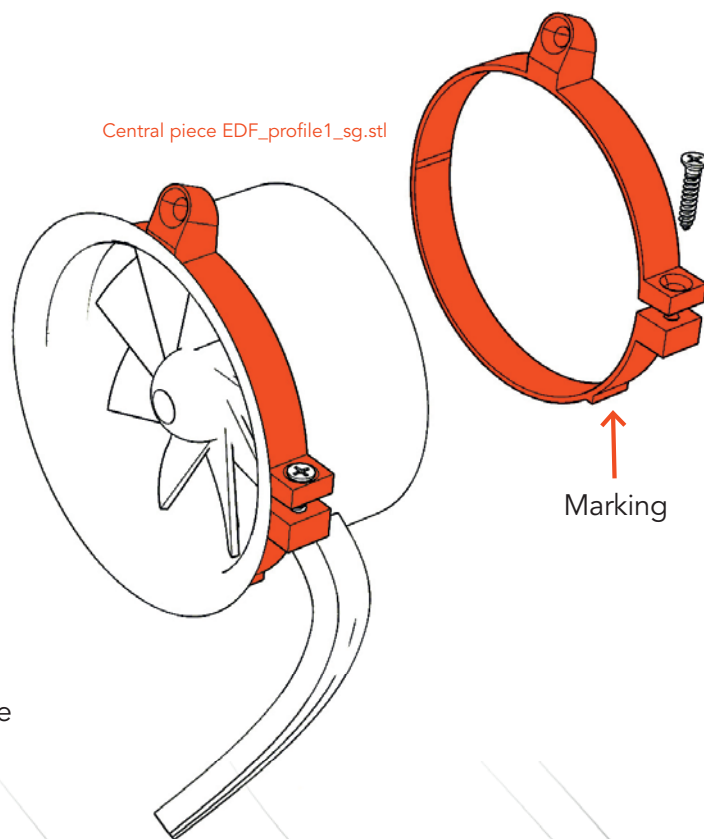

Then insert the EDF into the push tube and screw it into place at the top.

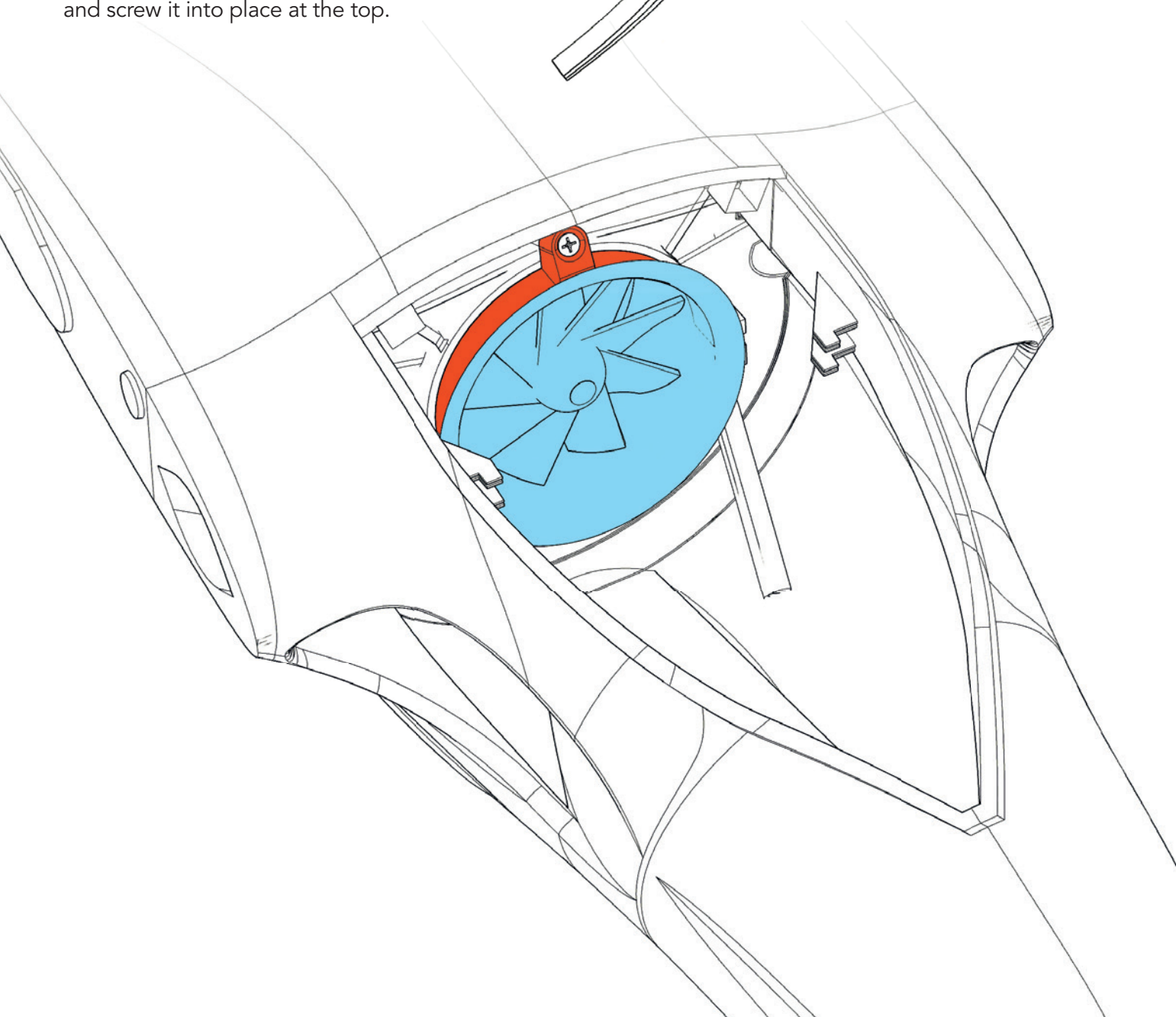

RC components

Use self-adhesive Velcro tape to attach the RC components.

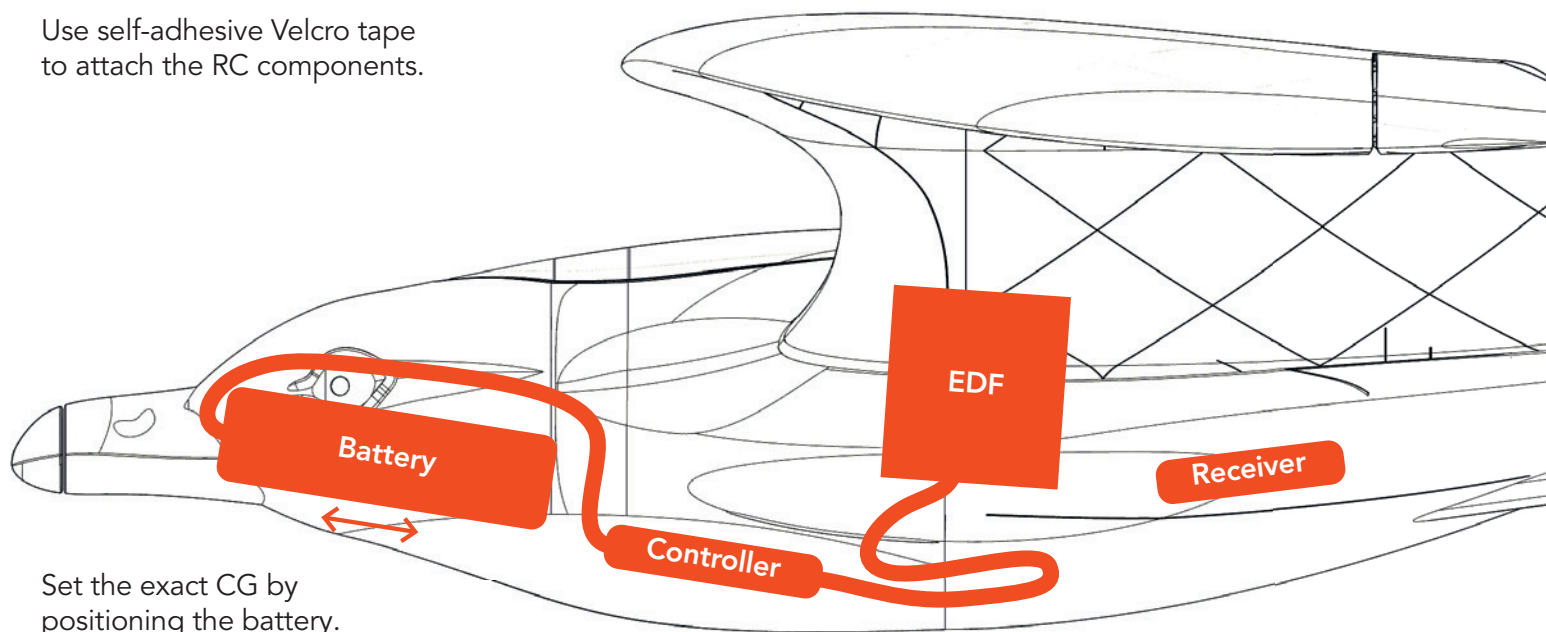

Set the exact CG by positioning the battery.

Center of Gravity (CG)

The aircraft must balance these points.

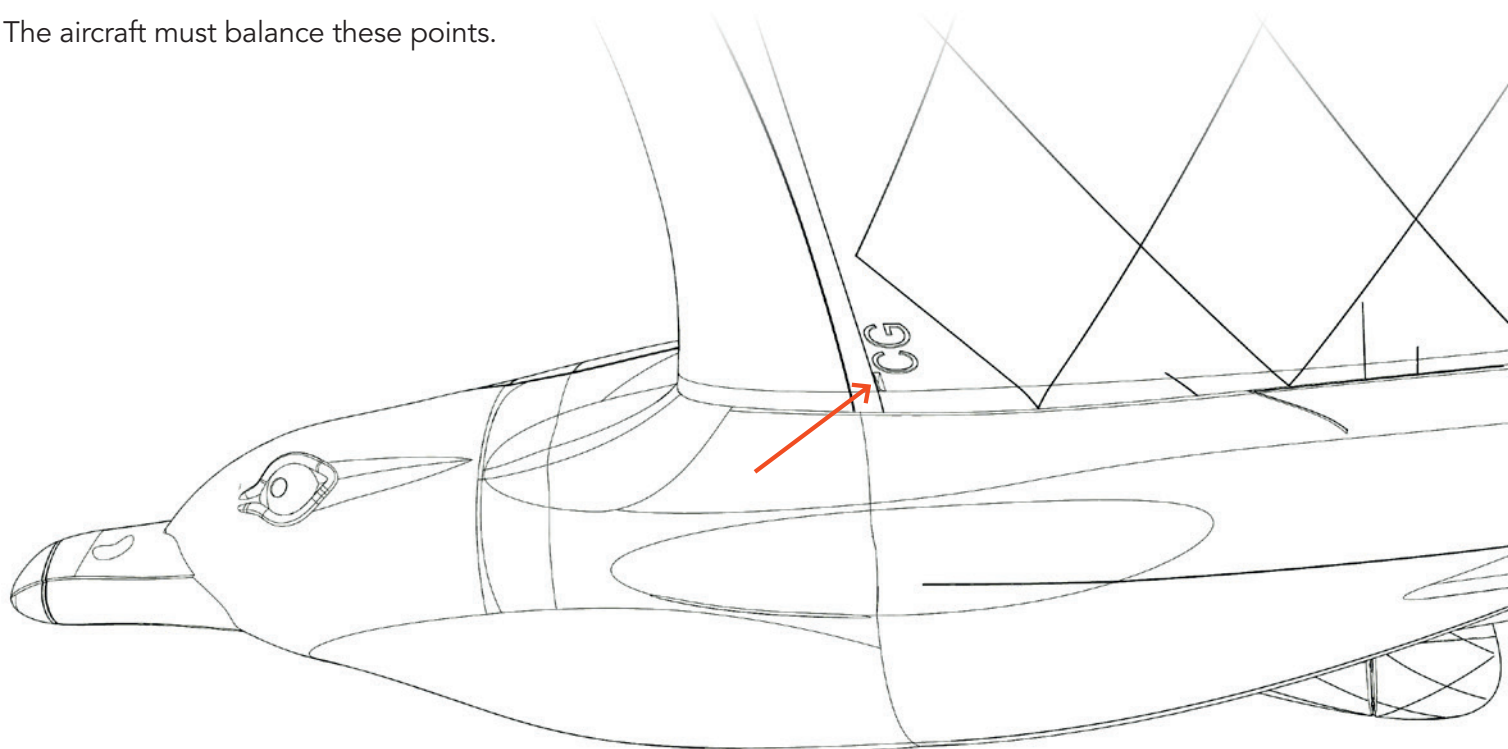

Control Direction Test

Turn on the transmitter and connect the battery.
When checking the control directions, **look at the aircraft from behind.**

Elevator up



Elevator down



Aileron left

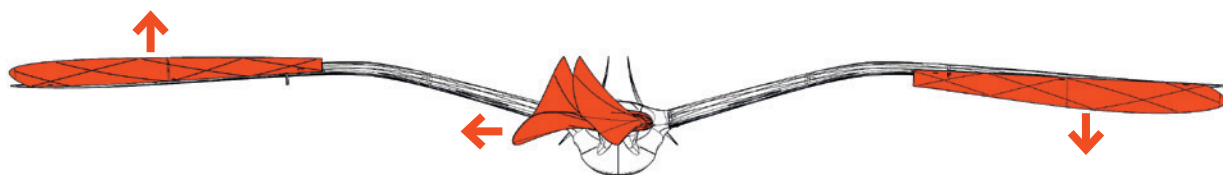
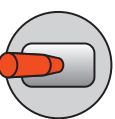

Aileron right

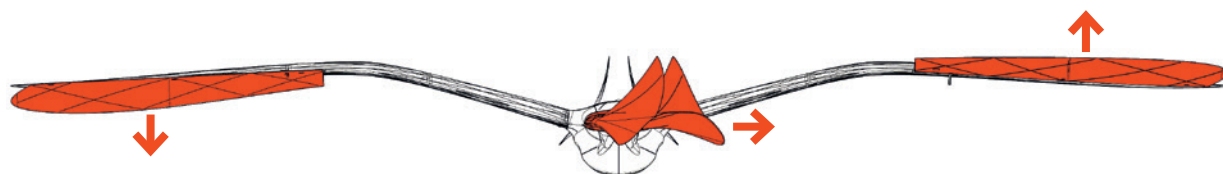
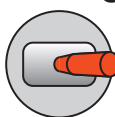

Rudder left

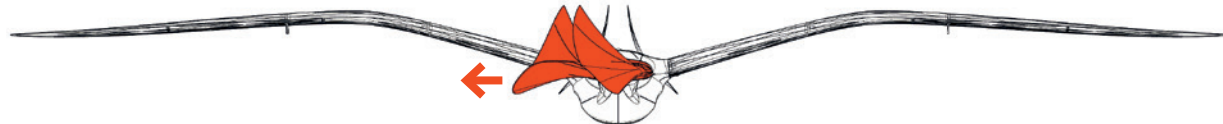
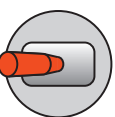

Rudder right

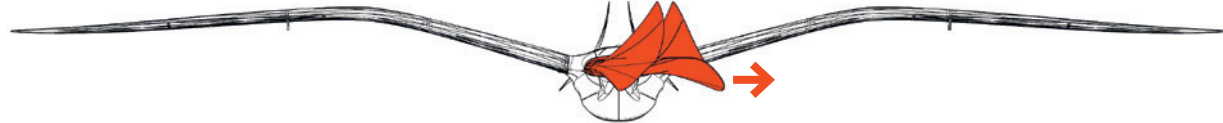
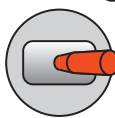

SETTINGS FOR FLYING

The Seagull must be **programmed like a flying wing (delta)**. This means that the ailerons also take over the elevator function. Since the Seagull requires the simultaneous use of aileron and rudder to initiate the turn for optimum flight characteristics, we recommend that you **also mix rudder to aileron function**. This means that with the aileron, the rudder also moves a little. We recommend **about 50 %**. When the rudder is actuated, only the rudder should be moved.

Setting the servo travel

With the recommended CG, the basic setting of the ailerons/elevators should be as shown here. It is **imperative** that at thrust of the EDF, the ailerons/elevators are set down.

IMPORTANT! You must activate a mixer to mix the ailerons/elevators to the throttle setting!

The mixer must be **linear**:
zero throttle: aileron/elevator 2mm up
half throttle: aileron/elevator 0.5mm down
full throttle: aileron/elevator 3mm down

Aileron/Elevator default setting in gliding:

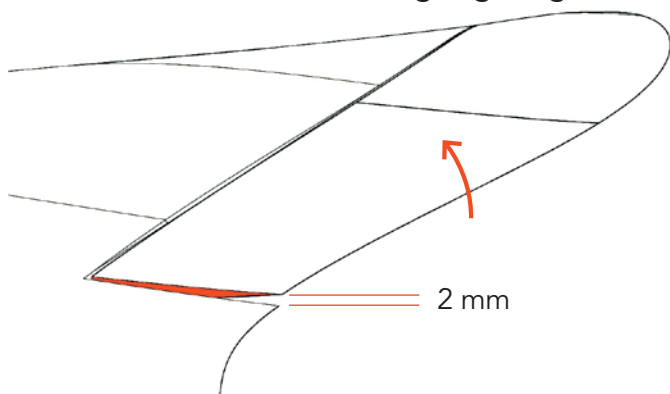

Aileron/Elevator default setting at full throttle:

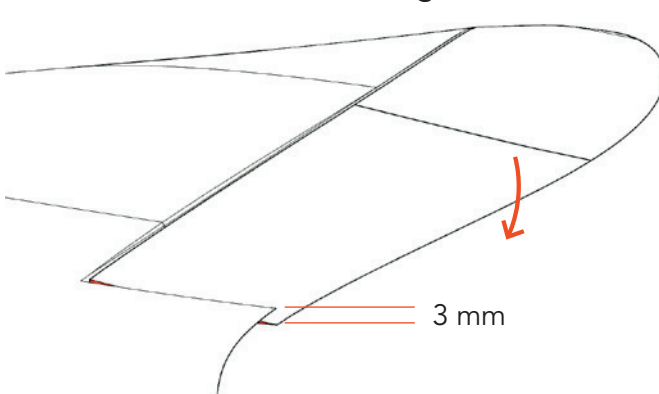

The Seagull has the maximum flight performance in gliding flight when the CG is a little further back. After a few flights you can **carefully** move the CG a bit backwards until the ailerons/elevators can be adjusted neutrally (no longer 2 mm upwards).

Deviating from this setting, this maximum travel must be set:

ELEVATOR up: 11 mm, down: 11 mm

AILERON up: 11 mm, down: 11 mm

RUDDER left/right: 30 mm

Expo setting

ELEVATOR 20 % **RUDDER** 0 %

AILERON 20 %

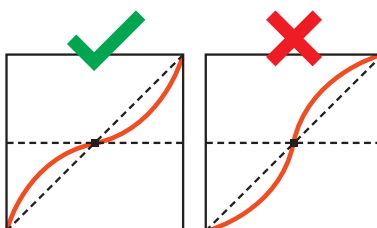

(for some remote controls a minus has to be in front of the number)

Takeoff from the hand

For safe launching, you should hold the Seagull at the marked spot in the forward fuselage area. For better grip, this area should be roughened slightly with sandpaper.

Do not start at full throttle! It is better to start with **half thrust** and then give full thrust.

NOTE When throwing, it is important that the bird is **pulled** forward, not pushed. Therefore you should not support it behind with your index finger (see picture)!

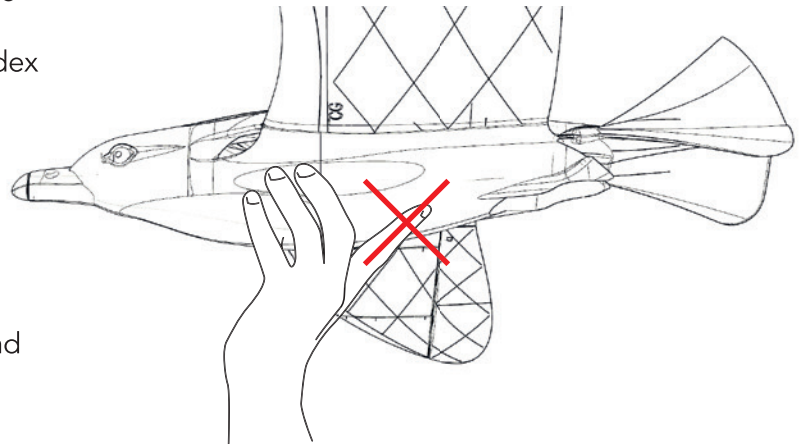
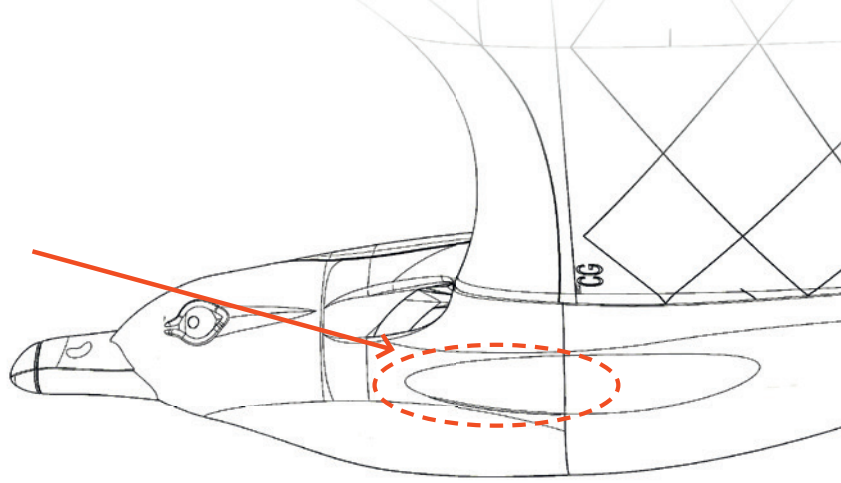

Landing

Make the seagull as slow as possible before touching down. It should not pierce the ground with its beak, because then it will be stopped hard and the structure will be very stressed.

TECHNICAL SPECIFICATIONS

WINGSPAN 1500 mm/59 inches

LENGHT 530 mm/20.8 inches

FLIGHT WEIGHT 560 grams

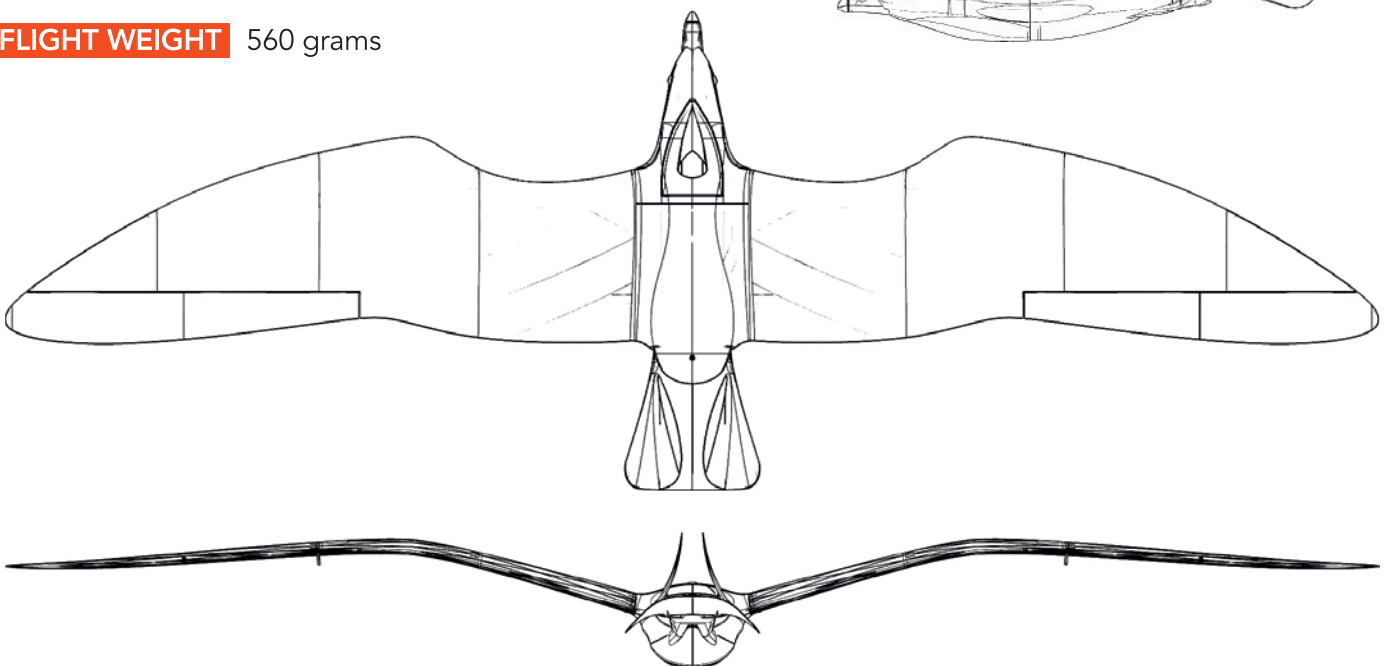
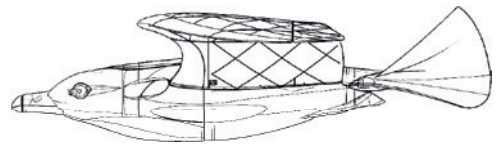

AGE RECOMMENDATION 14+

**NOT FOR CHILDREN UNDER 14 YEARS.
THIS IS NOT A TOY!**

By using the download data, an RC model airplane, called „model“ for short, can be manufactured using a 3D printer. As a user of this model, only you are responsible for safe operation that does not endanger you or others, or that does not damage the model or property of others.

PLANEPRINT.com assumes no responsibility for damage to persons and property caused by pressure, transport or use of the product. Filaments, printing supplies, hardware or consumables that can not be used after faulty 3D printing will not be replaced by PLANEPRINT.com in any way.

When operating, always keep a safe distance from your model in all directions to avoid collisions and injuries.

This model is controlled by a radio signal. Radio signals can be disturbed from outside without being able to influence it. Interference can lead to a temporary loss of control.

Always operate your model on open terrains, far from cars, traffic and people.

Always follow the instructions and warnings for this product and any optional accessories (servos, receivers, motors, propellers, chargers, rechargeable batteries, etc.) carefully.

Keep all chemicals, small parts and electrical components out of the reach of children.

Avoid water contact with all components that are not specially designed and protected. Moisture damages the electronics.

Never take an item of the model or accessory in your mouth as this can lead to severe injuries or even death.

Never operate your model with low batteries in the transmitter or model.

Always keep the model in view and under control. Use only fully charged batteries.

Always keep the transmitter switched on when the model is switched on.

Always remove the battery before disassembling the model.

Keep moving parts clean and dry at all times.

Always allow the parts to cool before touching them.

Always remove the battery after use.

Make sure that the Failsafe is properly set before the flight.

Never operate the model with damaged wiring.

Never touch moving parts.

We develop our models to the best of our knowledge and belief. We accept no liability for consequential damage and injuries caused by improper use. **Please be careful when handling motors, batteries and propellers** and only move your model with insurance and in approved places!

**PLANE
PRINT.com**

very light 3d printable rc planes